

# RIVER

WIDE  
SUPERSIZE SLABS

**NATURALE RAFFINATEZZA**  
eleganti micro texture per vestire  
gli spazi più trendy

*Natural appeal and elegance  
Stylish micro-textures for the most  
sophisticated spaces*



**FLAVIKER**  
CONTEMPORARY ECO CERAMICS

WIDE

SUPERSIZE SLABS

TECNOLOGIA AVANZATA  
AL SERVIZIO DELL'ARCHITETTURA  
CONTEMPORANEA

*Advanced technology for contemporary architecture*

---



Una texture elegante che richiama la natura, senza necessariamente imitare la pietra o altri elementi ben precisi. Piccoli ciottoli, occasionalmente interrotti da sottili venature, compongono una nuova superficie in grado di vestire gli spazi più trendy. Con 2 diverse finiture indoor, 1 superficie per esterni e 2 spessori, RIVER offre un vasto programma che include sia le grandi lastre WIDE che i piccoli sottomultipli da utilizzare come nuovi elementi Decor.

## RIVER

*An elegant texture that evokes nature without necessarily imitating stone or other specific materials. Small pebbles, interrupted here and there by thin veins, form a new surface ideal for use in the most trendy spaces. With 2 different indoor finishes, 1 surface for exteriors and 2 thicknesses, the RIVER collection consists of a wide range of offerings including WIDE slabs and small submultiples for use as new Decor elements.*



LEAD



MOON



EARTH



ECRU





Flaviker's WIDE collection consists of tough yet lightweight porcelain slabs with a thickness of just 7 mm and a record size of 160x320 cm produced using the revolutionary CONTINUA+ technology. The new pressing system involves dry compaction of raw materials and is able to produce surfaces that combine excellent aesthetic quality with outstanding technical performance.

**WIDE**  
SUPERSIZE SLABS

## CERAMIC R-EVOLUTION

Il progetto WIDE Flaviker parte dalla rivoluzionaria tecnologia produttiva CONTINUA+, che permette di produrre lastre in gres porcellanato robuste e leggere allo stesso tempo, grazie allo spessore ridotto di 7mm, fino alla dimensione record di 160x320 cm. Il nuovo sistema di pressatura prevede la compattazione a secco delle materie prime e consente di ottenere superfici particolarmente apprezzabili sia per la qualità estetica che per le performance tecniche.

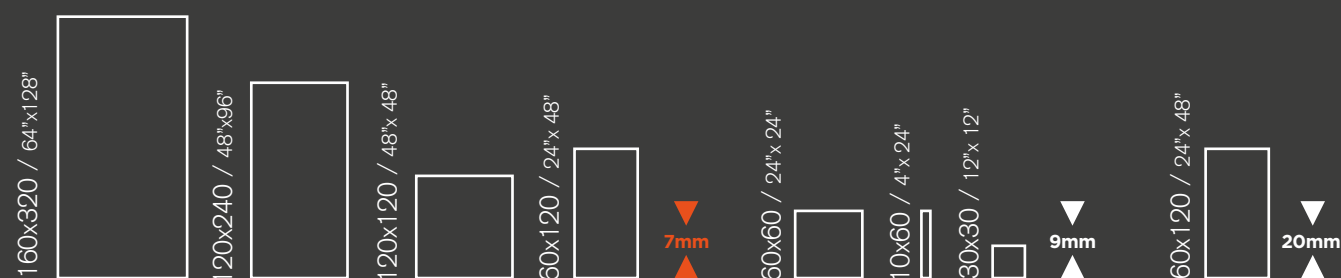



Attraverso il progetto WIDE è possibile personalizzare ogni ambiente, a partire dalle diverse sensazioni materiche offerte dalla gamma. Pietra, marmo e legno si alternano a superfici di design che richiamano i cementi industriali.

---

**WIDE**  
SUPERSIZE SLABS

## **MULTIPLE SENSATIONS**

*The WIDE collection is inspired by a range of materials ideal for customising any space. Stone, marble and wood alternate with design surfaces reminiscent of industrial.*



**RIVER**  
EARTH











**RIVER** EARTH RETT. 120X120 **COZY** BROWN 26X200 TABLES: **SUPREME** CALACATTA EXTRA RETT. 120X120





**HYPER** TAUPE 60X120

**W\_ALL** STONE BEIGE 30X120

**RIVER** EARTH RETT. 60X120, 120X240, MOSAICO 30X30







# RIVER LEAD

---

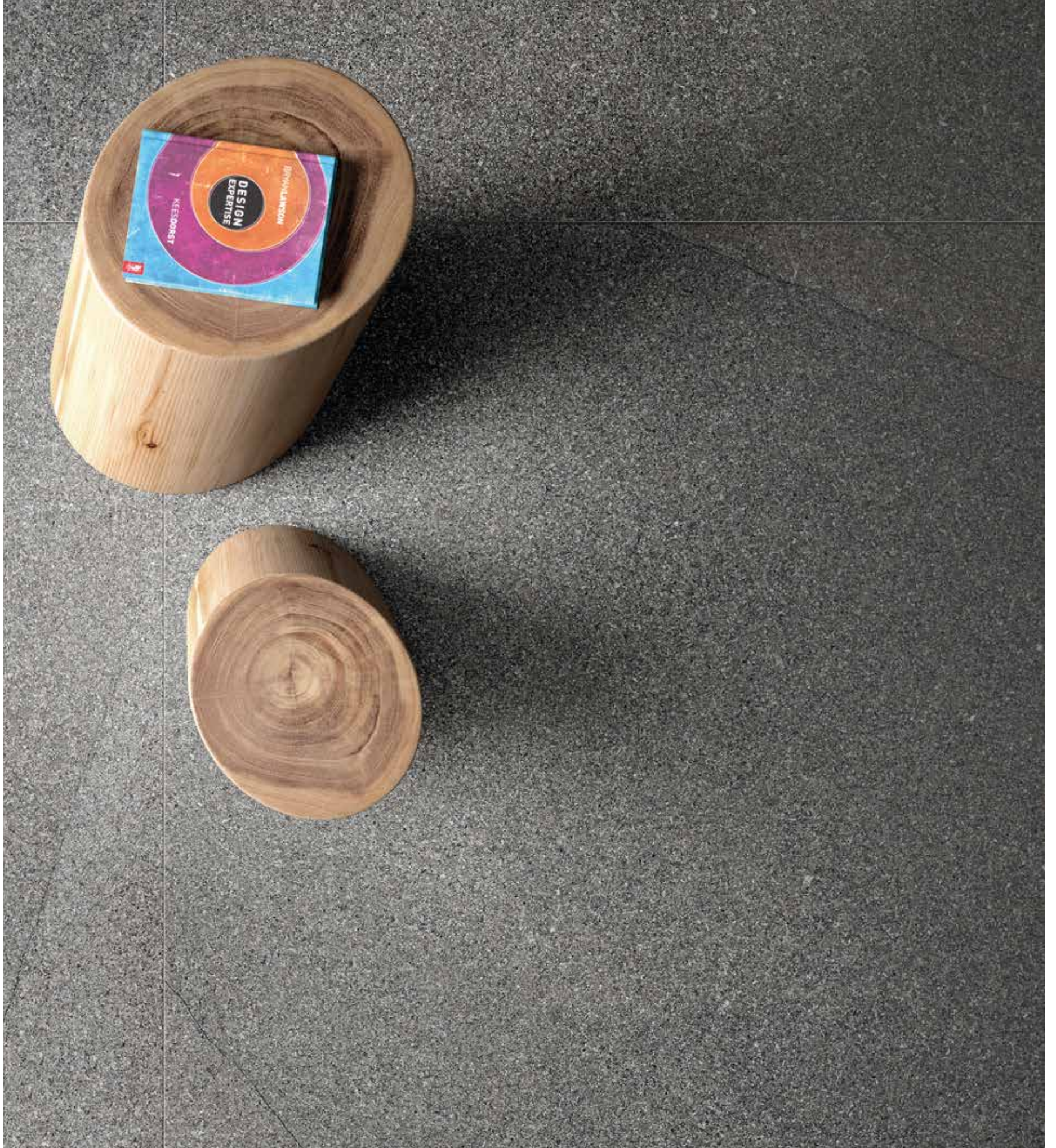





RIVER LEAD LAPP 120X240, 120X120 SUPREME STATUARIO VENATO LUX+ 120X240





RIVER LEAD LAPP 120X240, 120X120 SUPREME STATUARIO VENATO LUX+ 120X240











**RIVER** LEAD RETT. 120X240, 60X120, SHADE 120X240  
WASHBASIN SHELF: **COZY** BARK 26X200





**RIVER** LEAD RETT. 160X320 **HANGAR** COAL 80X160





RIVER LEAD RETT. 60X60 / ECRU RETT. 10X60





**RIVER**  
ECRU

---

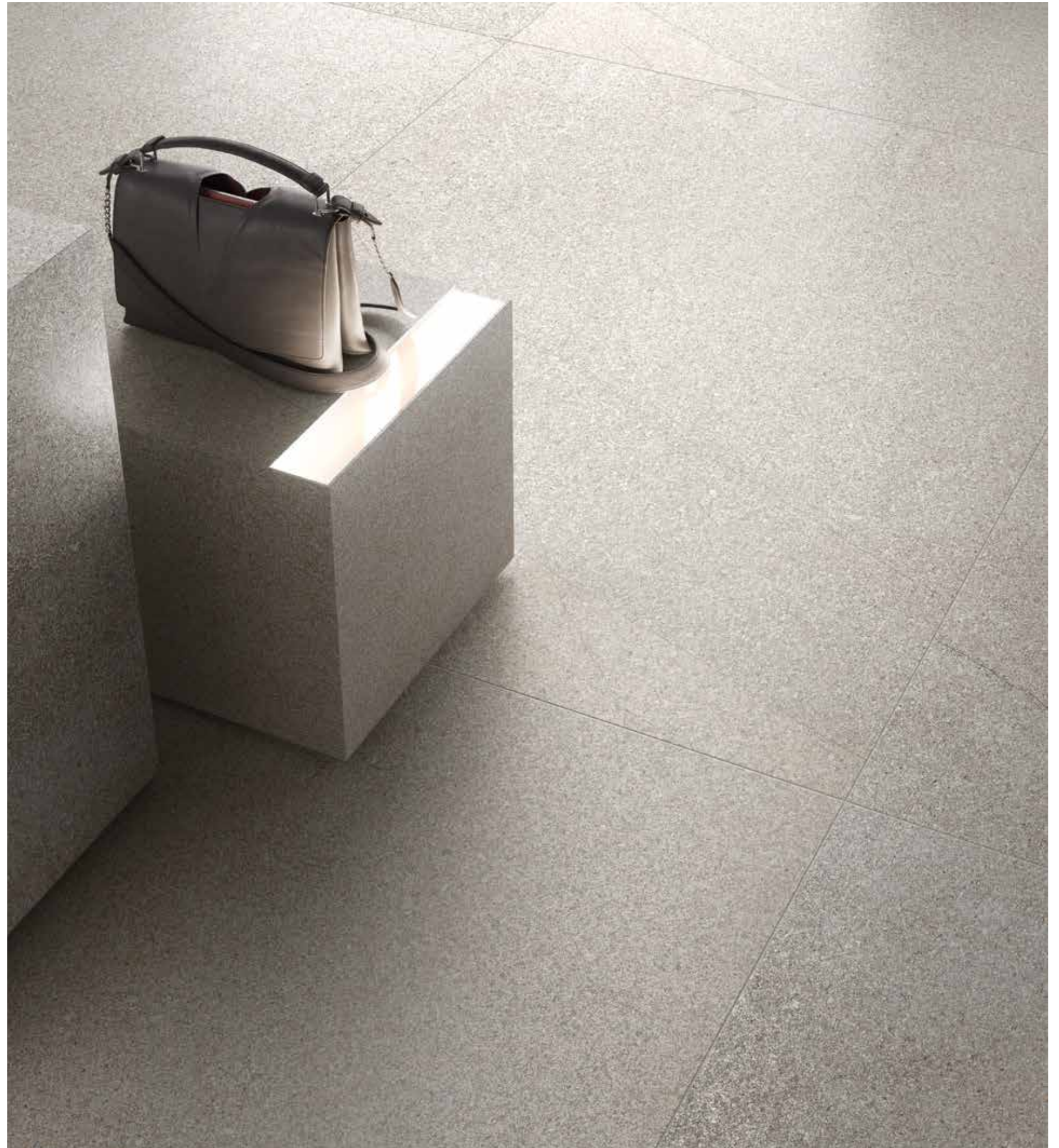









**RIVER** ECRU RETT. 120X240 **SUPREME** NOIR LAURENT LUX+ 120X240



**RIVER** ECRU RETT. SHADE 120X120



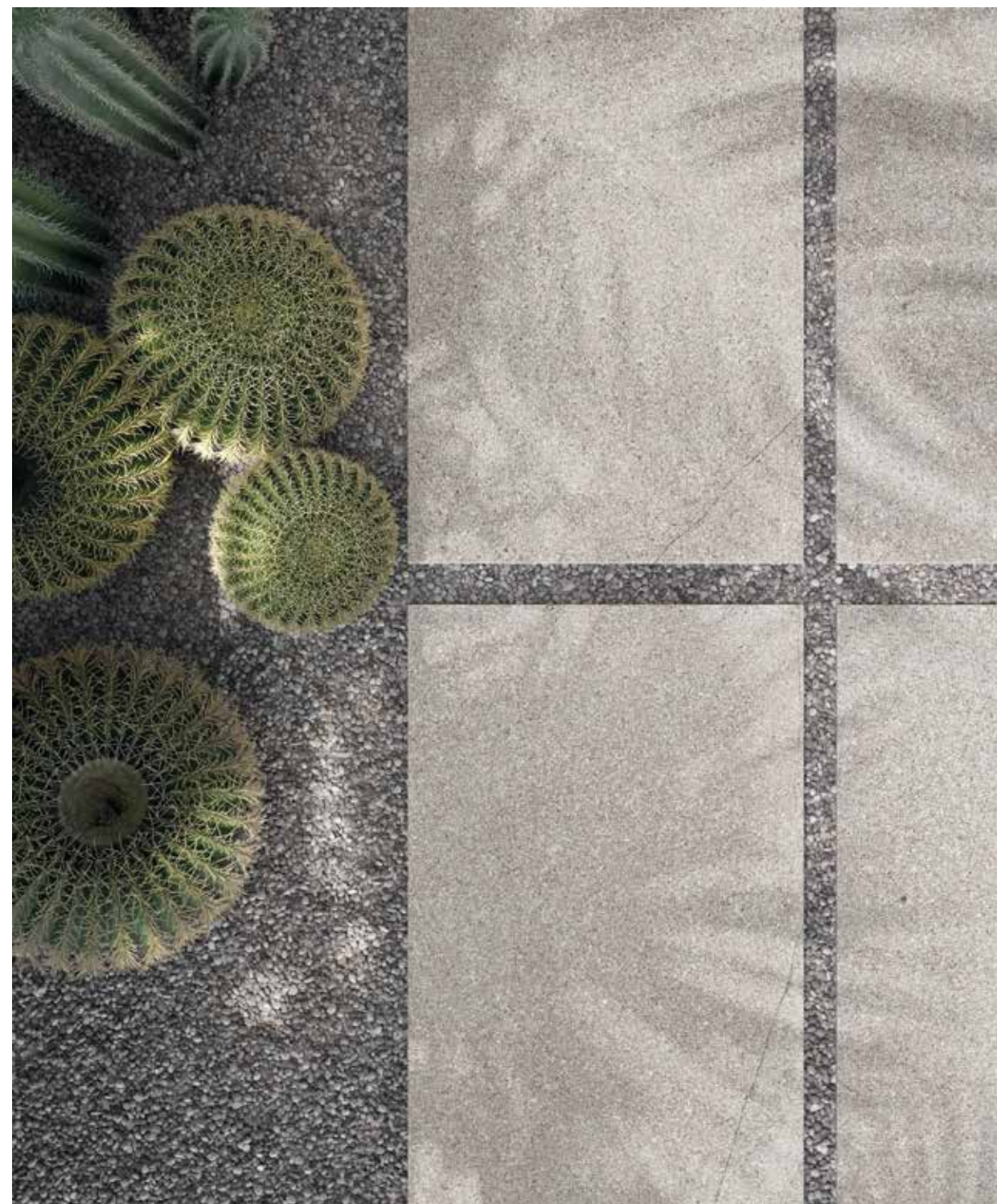
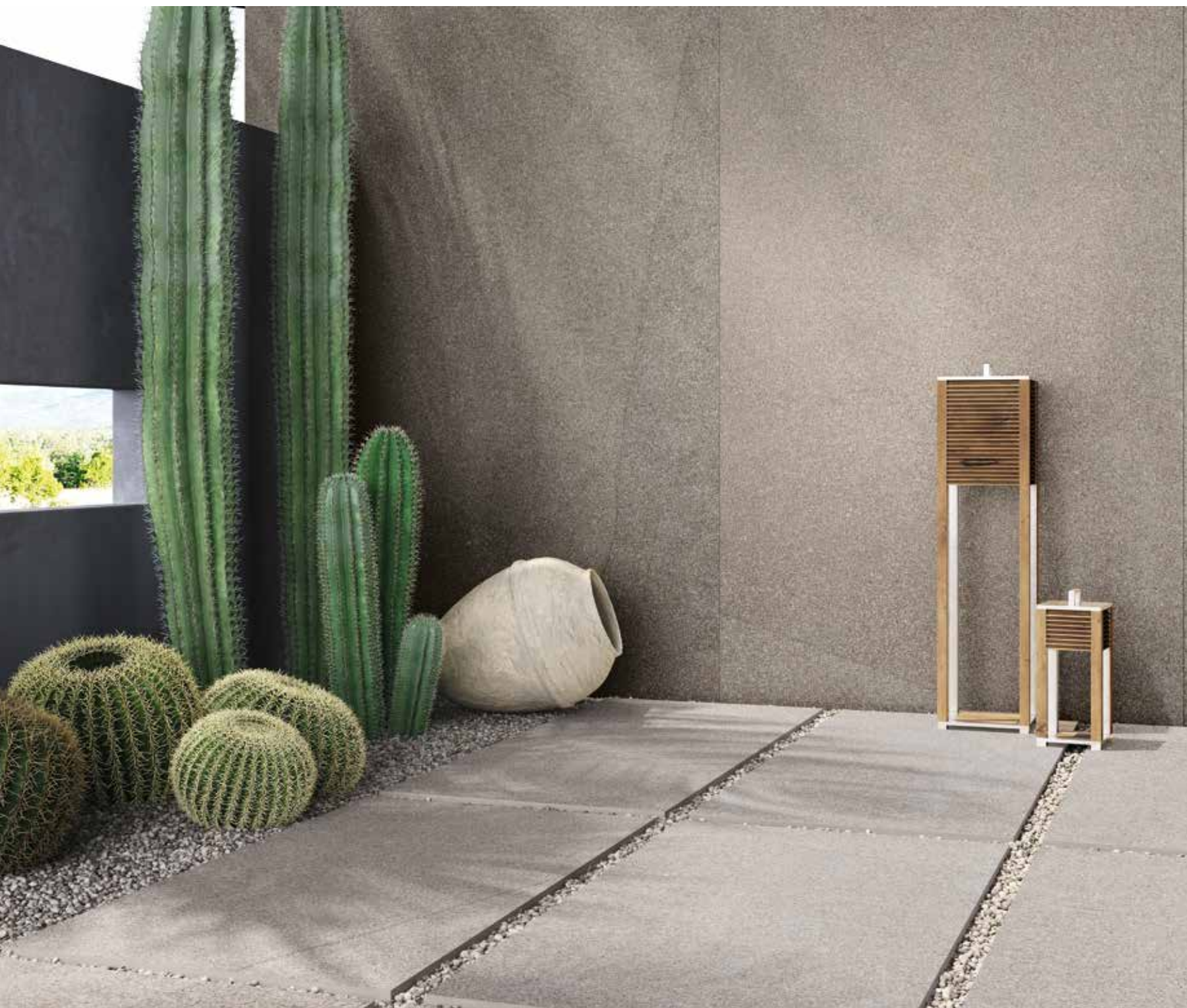

**RIVER** EARTH RETT. 120X240 / X20 ECRU 60X120 20MM RETT.



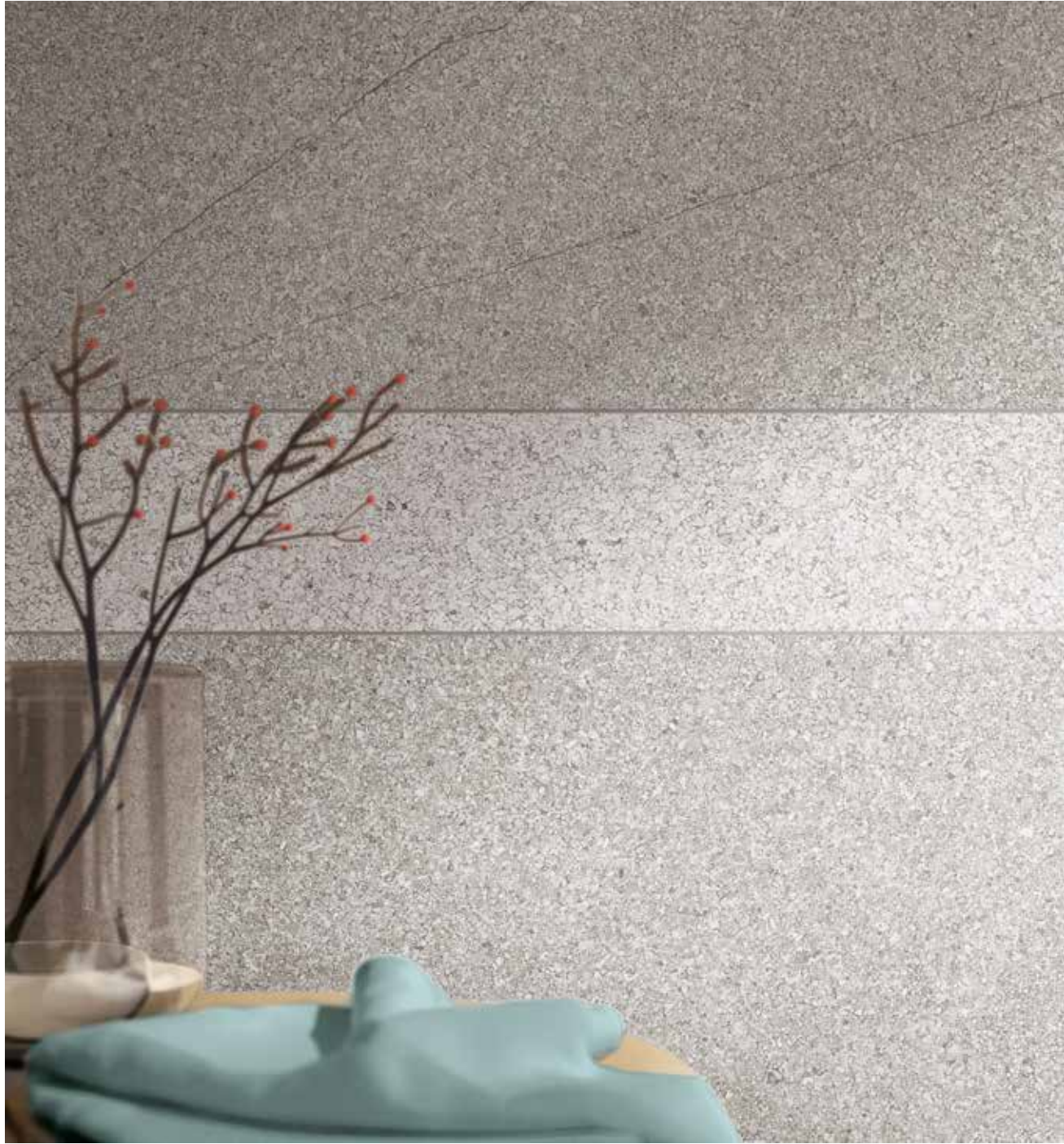

**RIVER** ECRU RETT. 60X120 / **MOON** RETT. 10X60 **HYPHER** SILVER RETT. 60X120

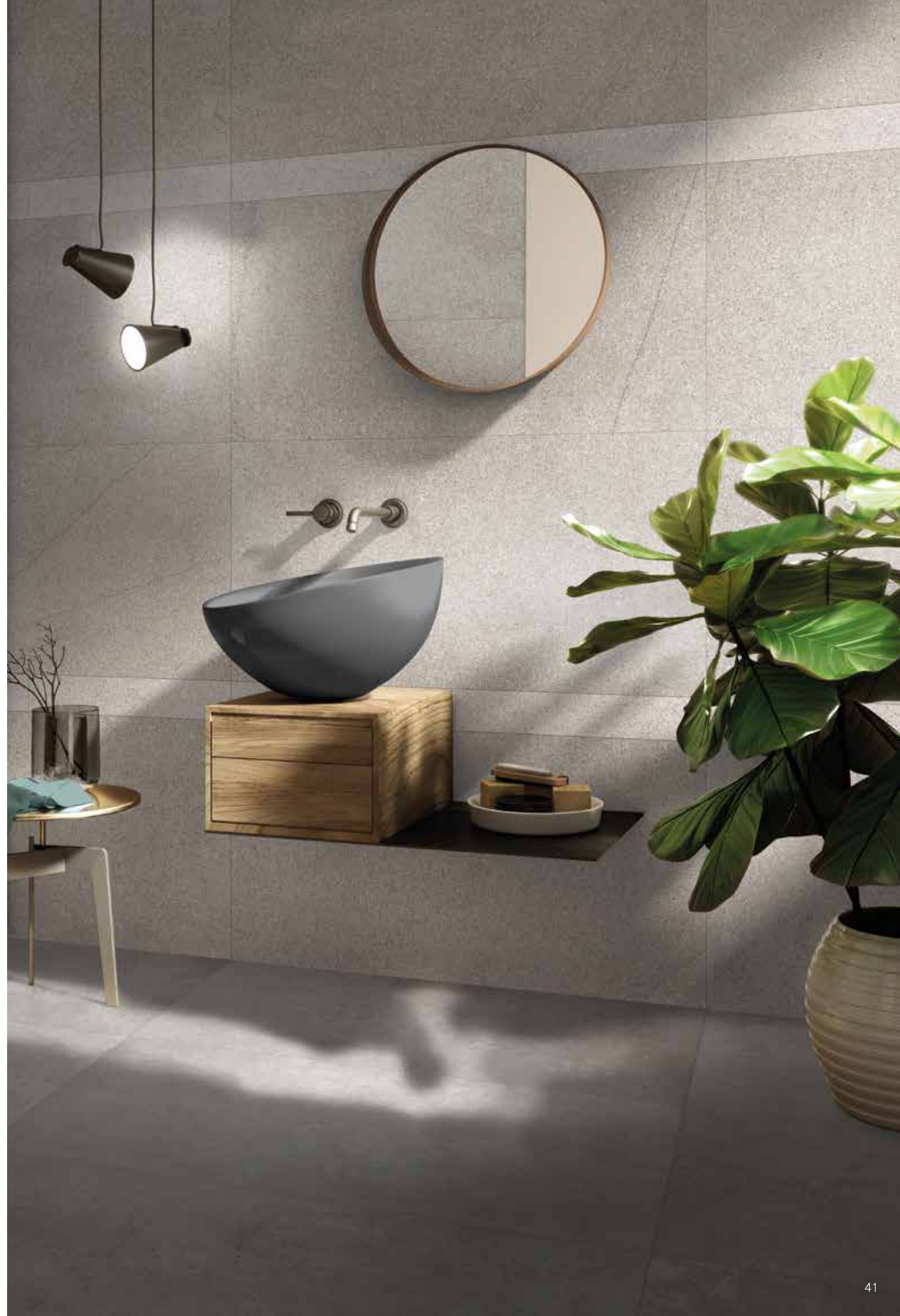



**RIVER**  
MOON

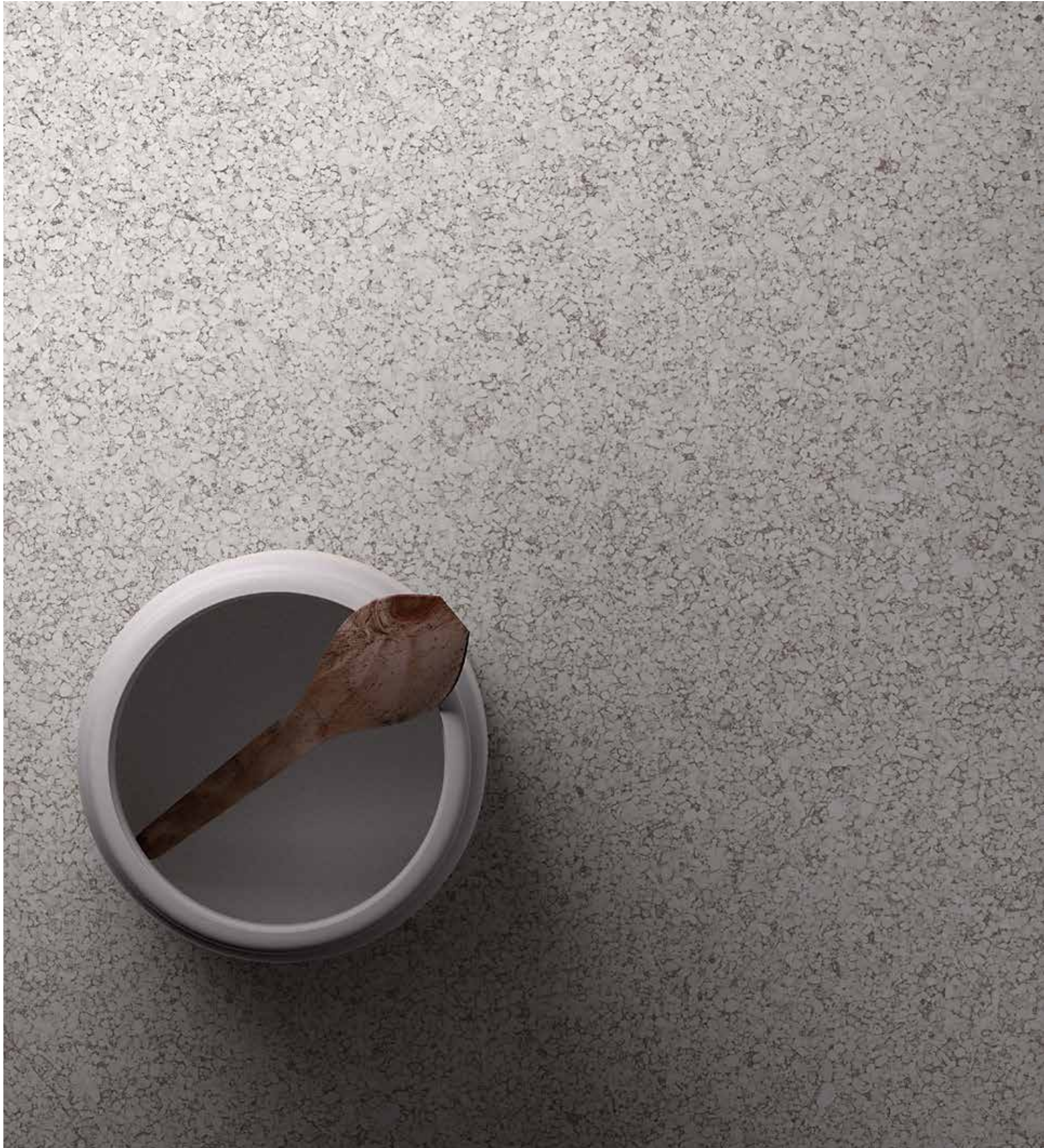







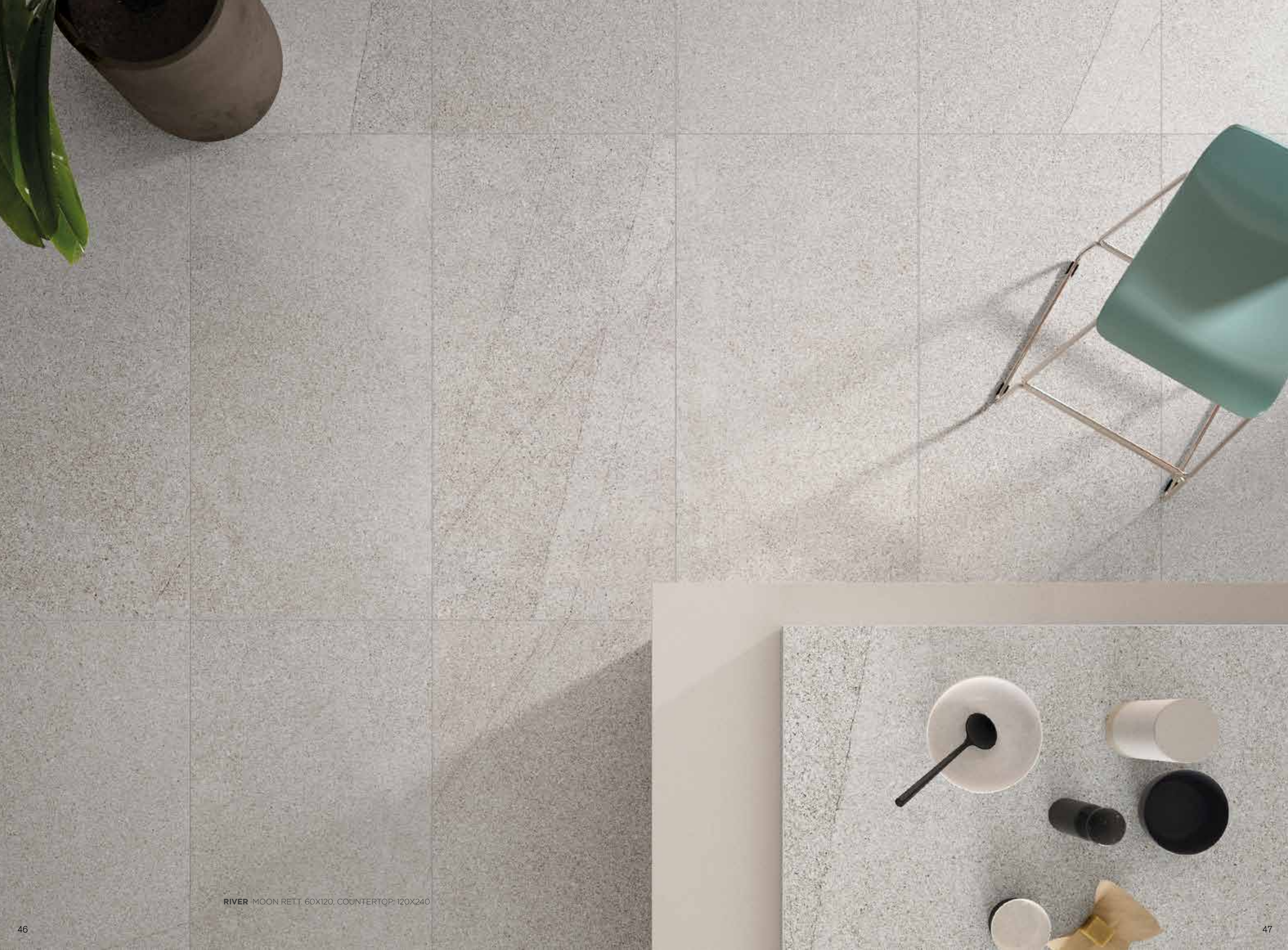

RIVER MOON RETT. 60X120. COUNTERTOP: 120X240





RIVER MOON RETT. 60X120, COUNTERTOP: 120X240

RIVER MOON RETT. 60X120 STILL NO\_W COAL 120X120, MOS. TRIANGOLI







160X320

### NATURALE NATURAL 7 mm

160x320	RETT.	0001751	M. 168,00
120x240	RETT.	0001759	M. 132,00
120x120	RETT.	0001767	M. 102,00
60x120	RETT.	0001771	M. 70,00
10x60	RETT.	0002841	M. 57,50

9 mm

60x60	RETT.	0001775	M. 53,50
30x30	RETT.	0002380	M. 66,00
10x60	RETT.	0002384	M. 57,50

#### 30x30

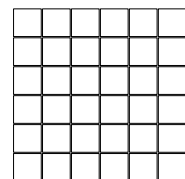

0002376 7 mm  
MOSAICO EARTH RETT.  
M. 104,00 5

### LAPPATO HONED 7 mm

120x240	LAPP. RETT.	0002287	M. 149,00
120x120	LAPP. RETT.	0001783	M. 119,00
60x120	LAPP. RETT.	0002291	M. 80,00

7 mm

	<b>BATTISCOPA</b>	5,5x120
<span style="border: 1px solid black; padding: 2px;">6</span>	RETT.	0002327 P. 9,50
	LAPP. RETT.	0002359 P. 12,50

	<b>GRADONE PLUS</b>	32x120x4,5x1,5
<span style="border: 1px solid black; padding: 2px;">6</span>	RETT.	0002331 P. 169,00
	LAPP. RETT.	0002363 P. 179,00

	<b>ANGOLARE PLUS SX</b>	32x120x4,5x1,5
<span style="border: 1px solid black; padding: 2px;">6</span>	RETT.	0002335 P. 196,00
	LAPP. RETT.	0002367 P. 206,00

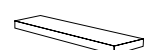
	<b>ANGOLARE PLUS DX</b>	32x120x4,5x1,5
<span style="border: 1px solid black; padding: 2px;">6</span>	RETT.	0002339 P. 196,00
	LAPP. RETT.	0002371 P. 206,00

9 mm

	<b>BATTISCOPA</b>	5,5x60
<span style="border: 1px solid black; padding: 2px;">10</span>	RETT.	0002827 P. 6,50



160X320

### NATURALE NATURAL 7 mm

160x320	RETT.	0001752	M. 168,00
120x240	RETT.	0001760	M. 132,00
120x120	RETT.	0001768	M. 102,00
60x120	RETT.	0001772	M. 70,00
10x60	RETT.	0002842	M. 57,50

9 mm

60x60	RETT.	0001776	M. 53,50
30x30	RETT.	0002381	M. 66,00
10x60	RETT.	0002385	M. 57,50

#### 30x30

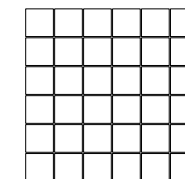



0002377 7 mm  
MOSAICO LEAD RETT.  
M. 104,00 5

### LAPPATO HONED 7 mm

120x240	LAPP. RETT.	0002288	M. 149,00
120x120	LAPP. RETT.	0001784	M. 119,00
60x120	LAPP. RETT.	0002292	M. 80,00

7 mm

	<b>BATTISCOPA</b>	5,5x120
<span style="border: 1px solid black; padding: 2px;">6</span>	RETT.	0002328 P. 9,50
	LAPP. RETT.	0002360 P. 12,50

	<b>GRADONE PLUS</b>	32x120x4,5x1,5
<span style="border: 1px solid black; padding: 2px;">6</span>	RETT.	0002332 P. 169,00
	LAPP. RETT.	0002364 P. 179,00

	<b>ANGOLARE PLUS SX</b>	32x120x4,5x1,5
<span style="border: 1px solid black; padding: 2px;">6</span>	RETT.	0002336 P. 196,00
	LAPP. RETT.	0002368 P. 206,00

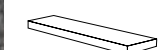
	<b>ANGOLARE PLUS DX</b>	32x120x4,5x1,5
<span style="border: 1px solid black; padding: 2px;">6</span>	RETT.	0002340 P. 196,00
	LAPP. RETT.	0002372 P. 206,00

9 mm

	<b>BATTISCOPA</b>	5,5x60
<span style="border: 1px solid black; padding: 2px;">10</span>	RETT.	0002828 P. 6,50





160X320

**NATURALE** NATURAL 7 mm

160x320	RETT.	0001750	M. 168,00
120x240	RETT.	0001758	M. 132,00
120x120	RETT.	0001766	M. 102,00
60x120	RETT.	0001770	M. 70,00
10x60	RETT.	0002840	M. 57,50

9 mm

60x60	RETT.	0001774	M. 53,50
30x30	RETT.	0002379	M. 66,00
10x60	RETT.	0002383	M. 57,50

30x30

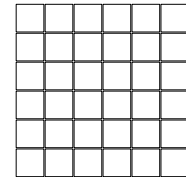

0002375 7 mm  
MOSAICO ECRU RETT.  
M. 104,00

**LAPPATO** HONED 7 mm

120x240	LAPP. RETT.	0002286	M. 149,00
120x120	LAPP. RETT.	0001782	M. 119,00
60x120	LAPP. RETT.	0002290	M. 80,00

7 mm

	<b>BATTISCOPA</b>	5,5x120
	RETT.	0002326 P. 9,50
	LAPP. RETT.	0002358 P. 12,50

	<b>GRADONE PLUS</b>	32x120x4,5x1,5
	RETT.	0002330 P. 169,00
	LAPP. RETT.	0002362 P. 179,00

	<b>ANGOLARE PLUS SX</b>	32x120x4,5x1,5
	RETT.	0002334 P. 196,00
	LAPP. RETT.	0002366 P. 206,00

	<b>ANGOLARE PLUS DX</b>	32x120x4,5x1,5
	RETT.	0002338 P. 196,00
	LAPP. RETT.	0002370 P. 206,00

9 mm

	<b>BATTISCOPA</b>	5,5x60
	RETT.	0002826 P. 6,50



160X320

**NATURALE** NATURAL 7 mm

160x320	RETT.	0001749	M. 168,00
120x240	RETT.	0001757	M. 132,00
120x120	RETT.	0001765	M. 102,00
60x120	RETT.	0001769	M. 70,00
10x60	RETT.	0002839	M. 57,50

9 mm

60x60	RETT.	0001773	M. 53,50
30x30	RETT.	0002378	M. 66,00
10x60	RETT.	0002382	M. 57,50

30x30

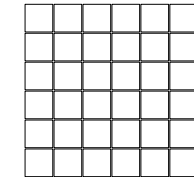

0002374 7 mm  
MOSAICO MOON  
RETT.   
M. 104,00

**LAPPATO** HONED 7 mm

120x240	LAPP. RETT.	0002285	M. 149,00
120x120	LAPP. RETT.	0001781	M. 119,00
60x120	LAPP. RETT.	0002289	M. 80,00

7 mm

	<b>BATTISCOPA</b>	5,5x120
	RETT.	0002325 P. 9,50
	LAPP. RETT.	0002357 P. 12,50

	<b>GRADONE PLUS</b>	32x120x4,5x1,5
	RETT.	0002329 P. 169,00
	LAPP. RETT.	0002361 P. 179,00

	<b>ANGOLARE PLUS SX</b>	32x120x4,5x1,5
	RETT.	0002333 P. 196,00
	LAPP. RETT.	0002365 P. 206,00

	<b>ANGOLARE PLUS DX</b>	32x120x4,5x1,5
	RETT.	0002337 P. 196,00
	LAPP. RETT.	0002369 P. 206,00

9 mm

	<b>BATTISCOPA</b>	5,5x60
	RETT.	0002825 P. 6,50



# RIVER

**WIDE** 7 mm  
SUPERSIZE SLABS



## SHADE LEAD

## SHADE ECRU

120x240	RETT. 7 mm	0002296	M. 132,00
120x120	RETT. 7 mm	0002298	M. 102,00
60x120	RETT. 7 mm	0002300	M. 70,00

120x240	RETT. 7 mm	0002295	M. 132,00
120x120	RETT. 7 mm	0002297	M. 102,00
60x120	RETT. 7 mm	0002299	M. 70,00

# X 20 RIVER 20MM



60x120  
0001790 RIVER LEAD 20 mm RETT.  
M. 99,00



60x120  
0001789 RIVER ECRU 20 mm RETT.  
M. 99,00



15X60X5  
0002278 ELEMENTO L  
LEAD 20 mm RETT  
P. 89,00  
0002277 ELEMENTO L  
ECRU 20 mm RETT  
P. 89,00

15X60  
0002280 GRIGLIA  
LEAD 20 mm RETT  
P. 169,00  
0002279 GRIGLIA  
ECRU 20 mm RETT  
P. 169,00

15X60  
0002282 ANG. GRIGLIA SX  
LEAD 20 mm RETT  
P. 229,00  
0002281 ANG. GRIGLIA SX  
ECRU 20 mm RETT  
P. 229,00

15X60  
0002284 ANG. GRIGLIA DX  
LEAD 20 mm RETT  
P. 229,00  
0002283 ANG. GRIGLIA DX  
ECRU 20 mm RETT  
P. 229,00

**LASTRE IN GRES PORCELLANATO A MASSA COLORATA**  
FULL BODY COLORED PORCELAIN STONEWARE SLABS



### POSA TRADIZIONALE

La posa tradizionale è ideale per la realizzazione di pavimentazioni carrabili.

### TRADITIONAL INSTALLATION

Traditional installation is ideal for floorings that will be driven over by vehicles.



### POSA A SECCO SU GHIAIA

La posa su ghiaia permette il perfetto drenaggio delle acque piovane.

### DRY INSTALLATION ON GRAVEL

Installing on gravel enables perfect drainage of rainwater.



### POSA A SECCO SU ERBA

La posa diretta su erba permette di creare percorsi e camminamenti integrandosi perfettamente nell'ambiente.

### DRY INSTALLATION ON GRASS

Installing directly on top of grass enables the creation of paths and walkways that blend in perfectly with the surroundings.



### POSA A SECCO SU SABBIA

La posa su sabbia permette di creare percorsi e camminamenti per spiagge e stabilimenti balneari.

### DRY INSTALLATION ON SAND

Installing on top of sand is ideal for creating paths and walkways on beaches and beach bars.



### POSA SOPRAELEVATA DA ESTERNO

Il sistema di pavimentazione sopraelevata prevede l'utilizzo di supporti portanti di tipo autolivellante, regolabili oppure fissi che si adattano con semplicità e sicurezza ad ogni tipo di pavimento sottostante. Il sistema permette la realizzazione di piani di posa con altezze variabili, da terra, comprese fra 25 e 270 mm. L'indipendenza della pavimentazione dai supporti garantisce l'assorbimento di eventuali movimenti strutturali. Il sistema sopraelevato non necessita di massetto in cemento e consente una diminuzione del peso sulla struttura portante. Le fughe aperte tra una piastrella ed un'altra consentono un facile deflusso dell'acqua piovana evitando tutti i rischi di accumulo o di ristagno. La presenza dell'intercapedine fra il piano di calpestio e il piano di appoggio favorisce l'aerazione e l'isolamento termico. Questa soluzione permette inoltre il passaggio di impianti e tubazioni nell'intercapedine, e la facile ispezione degli stessi una volta installata la pavimentazione.

### OUTDOOR RAISED LAYING SYSTEM

The raised floor system foresees the use of self-levelling, adjustable or fixed load bearing supports that easily adapt to the floor below in total safety. The system is suitable to create laying designs with variable heights from the ground, which range between 25 and 270 mm. The independence of the flooring from the supports guarantees the absorption of any structural movements. The raised system does not require a cement screed and reduces the load on the bearing structure. The open joints between the tiles allow rainwater to easily drain off, avoiding any risk of water accumulation or stagnation. The gap between the tread surface and the support surface favours ventilation and heat insulation. This solution allows for the installation of systems and piping in the gap, which can be easily inspected even once the floor has been installed.



ESEMPIO DI REALIZZAZIONE ON DEMAND  
EXAMPLE OF ON DEMAND SERVICE REALIZATION

RIVER PEBBLE ON DEMAND / MOON NAT 120X240 / LEAD NAT 120X120



## COMPOSIZIONI DECORATIVE DECORATIVE COMPOSITIONS

Con un occhio attento alla decorazione di interni, FLAVIKER propone composizioni grafiche realizzate a idrogetto sulle lastre ceramiche in 7 mm. Le fughe, se esaltate con stucchi a contrasto, diventano motivo decorativo. Questi soggetti sono disponibili nel formato 120x240 cm, oppure adattabili a qualsiasi misura richiesta con il servizio ON DEMAND. Il cliente dovrà fornire le esatte dimensioni della superficie da rivestire; verrà poi realizzato un disegno esecutivo con relativo preventivo. Ogni singolo pezzo che compone il soggetto verrà numerato in modo da facilitare le operazioni di posa. Fuga tra i diversi pezzi 2 mm.

With a keen eye for interior decoration, FLAVIKER offers design compositions created from waterjet-cut 7 mm thick ceramic slabs. Contrasting coloured grout can be used to enhance the joints and create a decorative pattern. These designs are available in 120x240 cm slabs or can be adapted to surfaces of any size using the ON DEMAND service. The customer will need to provide the exact dimensions of the surface to be tiled, after which a detailed drawing and quote can be made. Each piece making up the design will be numbered for ease of installation. A 2 mm joint will be maintained between the individual tiles.

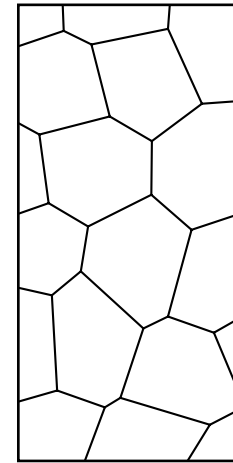

**PEBBLE** COMP. 120x240

	NATURALE NATURAL	LAPPATO HONED
EARTH	0002311	0002323
LEAD	0002312	0002324
ECRU	0002310	0002322
MOON	0002309	0002321

CP. 1.749,00

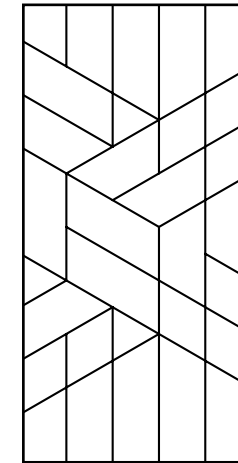

**TETRIS** COMP. 120x240

	NATURALE NATURAL	LAPPATO HONED
EARTH	0002307	0002319
LEAD	0002308	0002320
ECRU	0002306	0002318
MOON	0002305	0002317

CP. 1.749,00

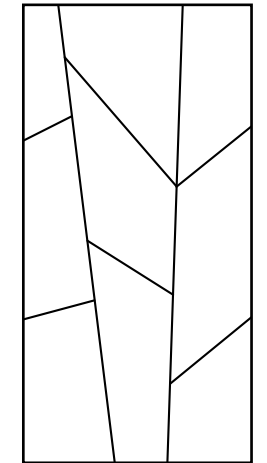

**THREE** COMP. 120x240

	NATURALE NATURAL	LAPPATO HONED
EARTH	0002303	0002315
LEAD	0002304	0002316
ECRU	0002302	0002314
MOON	0002301	0002313

CP. 1.749,00

COD. PER IL SERVIZIO SU MISURA ON DEMAND / ON DEMAND SERVICE CODE: 0000100 M. 739,00

## ESEMPI DI APPLICAZIONE EXAMPLES OF APPLICATION

COMP. 120X240

**Consigliata per posa a pezzo singolo**  
Recommended for single-piece installation

Altezza soffitto 400 cm, Altezza posa 240 cm

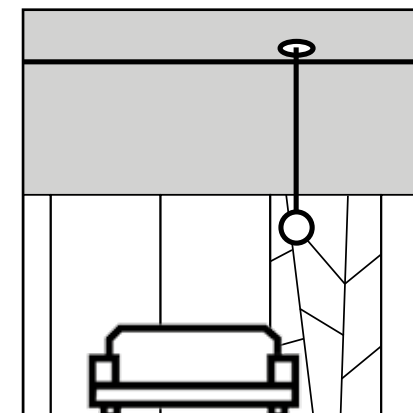

ON DEMAND

**Es. Posa alt. 240 cm in tutta la parete**  
Ex. Laying 240 cm height throughout the length of the wall

Altezza soffitto 400 cm, Altezza posa 240 cm

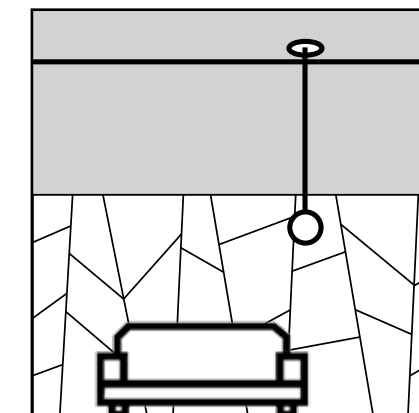

ON DEMAND

**Es. Posa a tutta parete**  
Ex. Laying full height tiles

Altezza soffitto 400 cm, Altezza posa 400 cm

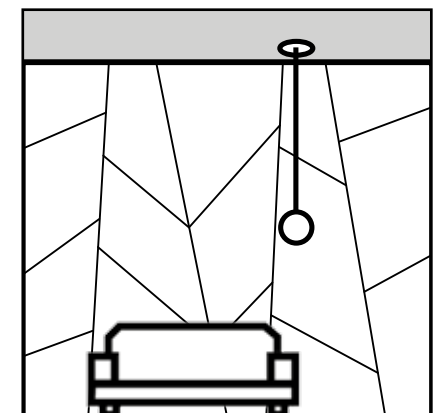



# WIDE

SUPERSIZE SLABS

LASTRE IN GRES PORCELLANATO A MASSA COLORATA  
FULL BODY COLORED PORCELAIN STONEWARE SLABS

## CERAMIC R-EVOLUTION

Il progetto WIDE Flaviker parte dalla rivoluzionaria tecnologia produttiva CONTINUA+, che permette di produrre lastre in gres porcellanato robuste e leggere allo stesso tempo, grazie allo spessore ridotto di 7mm, fino alla dimensione record di 160x320 cm. Il nuovo sistema di pressatura prevede la compattazione a secco delle materie prime e consente di ottenere superfici particolarmente apprezzabili sia per la qualità estetica che per le performance tecniche.

Flaviker's WIDE collection consists of tough yet lightweight porcelain slabs with a thickness of just 7 mm and a record size of 160x320 cm produced using the revolutionary CONTINUA+ technology. The new pressing system involves dry compaction of raw materials and is able to produce surfaces that combine excellent aesthetic quality with outstanding technical performance.



### WIDE & STRONG

WIDE è perfettamente idoneo sia per il rivestimento che per la pavimentazione, in ambito residenziale e commerciale. Lo spessore 7 mm consente di mantenere un'ottima resistenza al carico di rottura reale.

WIDE is ideal as both a floor and wall covering in residential and commercial projects. The 7 mm thickness enables it to maintain excellent breaking strength in real situations.



### LITE GOES WIDE

Lo spessore di 7 mm consente di ridurre il peso per mq con interessanti vantaggi in termini di maneggevolezza e movimentazione.

The 7 mm thickness results in a reduced weight per square metre, bringing significant advantages in terms of ease of working and handling.



### WIDE IS LEVELING

La combinazione fra impasto ad elevata plasticità, spessore e grande dimensione, dona particolare elasticità al prodotto, per ottenere risultati di posa sempre impeccabili.

The combination of a body with high plasticity, thickness and dimensions makes for a highly elastic product that delivers consistently flawless results.



### EASY AS WIDE

La formulazione dell'impasto, unita alla compattazione a secco e alla cottura in forni di nuova concezione, genera un gres particolarmente facile da tagliare e lavorare.

The chemical formulation of the body combined with the raw material dry compaction process produces a porcelain slab that is easy to cut and work with.



### WIDE MEANS GREEN

L'impasto contiene il 40% minimo di materie prime di qualità recuperate da altri processi produttivi, per questo i prodotti WIDE possono essere accreditati all'interno del sistema internazionale LEED.

As the body contains a minimum of 40% high-quality raw materials recycled from other production processes, WIDE collection products qualify for LEED international certification.

CARICO DI ROTTURA  
BREAKING STRENGTH

Flaviker 9 mm = 1.662 newton  
Flaviker 7mm = 1.587 newton  
Altri 6 mm = 1.166 newton

PESO  
WEIGHT

Flaviker 9 mm = 19,5 Kg x mq  
Flaviker 7 mm = 17,5 Kg x mq

indicatore di flessibilità flexibility index	deflessione massima sotto carico di 350 N maximum deflection under load of 350 N	lato/length 2400 mm	> 50 mm
		lato/length 3200 mm	> 100 mm

## EVERYWHERE YOU LIKE

Tenendo conto delle principali qualità del materiale, tra cui la robustezza, la resistenza agli sbalzi termici, oltre allo spessore contenuto e alla facilità di lavorazione, le grandi lastre WIDE ampliano la destinazione d'uso del gres porcellanato. Sempre meno fughe e sempre più spazio alla creatività di progettisti e interior designers, che grazie ai prodotti WIDE possono apprezzare la versatilità di una ceramica senza più confini.

Taking account of the material's key qualities, including strength, thermal shock resistance, low thickness and ease of working, the WIDE large-format slabs extend the fields of use of porcelain. The WIDE collection has fewer joints while giving enormous creative freedom to architects and interior designers, who appreciate the versatility of this ceramic surface without limits.



PAVIMENTI INTERNI  
INDOOR FLOORS



RIVESTIMENTI INTERNI  
INDOOR WALLS



FACCIAE ESTERNE  
INCOLLATE E VENTILATE  
GLUED AND VENTILATED  
EXTERIOR FAÇADES



PAVIMENTI AREE ESTERNE  
OUTDOOR FLOORS



PIANI LAVORO CUCINE  
KITCHEN COUNTERTOPS



TOP E FINITURE PER AMBIENTI  
BAGNO  
BATHROOM VANITY TOPS AND  
SHELVES



ELEMENTI DI ARREDO E  
DESIGN PER INTERNI  
INTERIOR FURNISHING AND  
DESIGN ELEMENTS

## NEW DIMENSIONS

Uno degli obiettivi del progetto WIDE è quello di fornire un materiale ceramico tecnologicamente avanzato facilmente utilizzabile in contesti anche molto diversi, per dimensione e per destinazione d'uso. WIDE è un vero e proprio programma di formati, tutti rettificati, pensati per coprire a 360° le esigenze legate alla progettazione, a partire dagli spazi residenziali, fino alle grandi opere in ambito pubblico e commerciale.

One of the aims of the WIDE project is to supply a hi-tech ceramic material that is easy to use in very different sizes and applications. WIDE comes in a large selection of sizes, all rectified, ideal for uses ranging from residential through to large-scale works in public and commercial spaces.

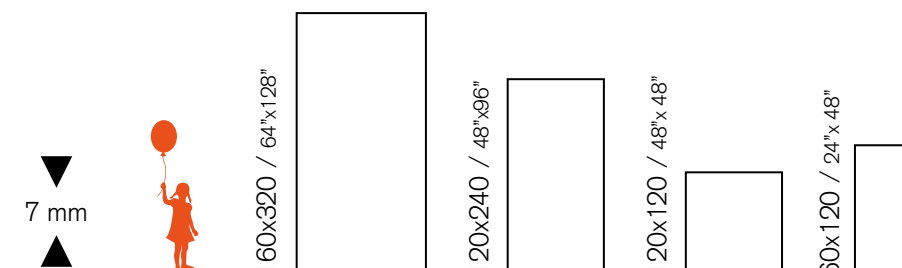



1.1 2 colori

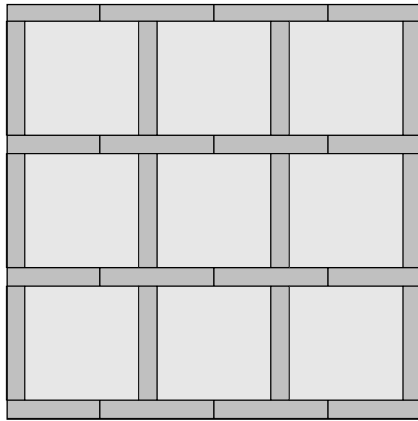

60X60 75%  (PAG. 30/31)  
10X60 25%

1.2 2 colori

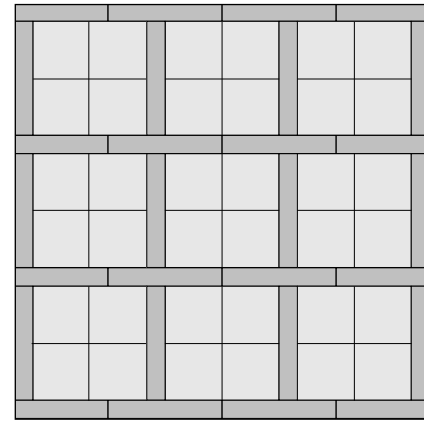

30X30 75%   
10X60 25%

1.3 3 colori

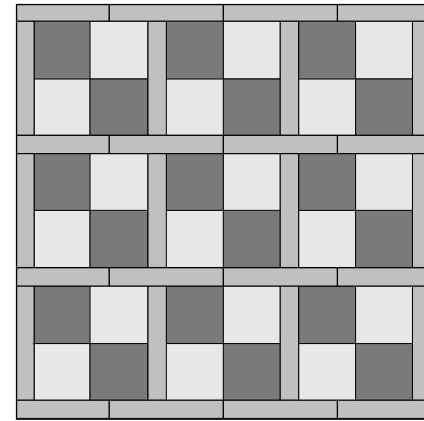

30X30 37.5%   
30X30 37.5%   
10X60 25%

2.1 2 colori

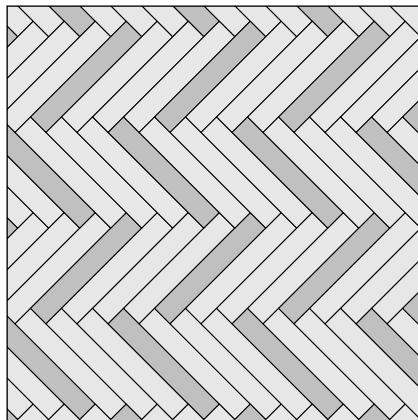

10X60 75%   
10X60 25%

2.2 2 colori

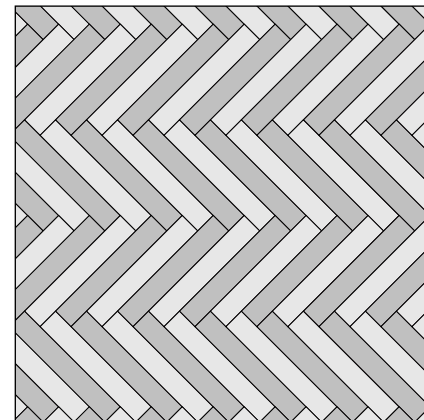

10X60 50%   
10X60 50%

2.3 4 colori

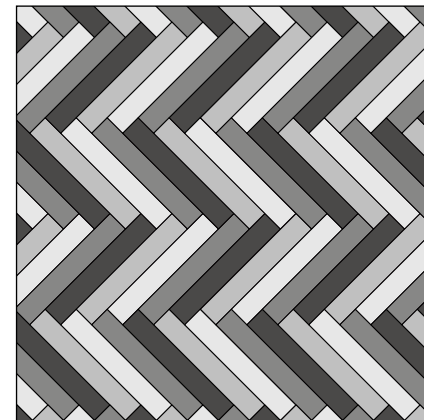

10X60 25%  10X60 25%   
10X60 25%  10X60 25%

3.1 3 colori

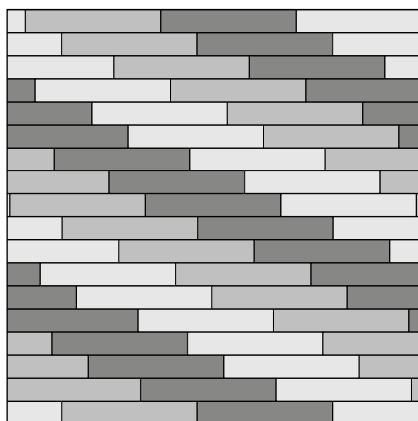

10X60 33.3%  10X60 33.3%   
10X60 33.3%

4.1 2 colori

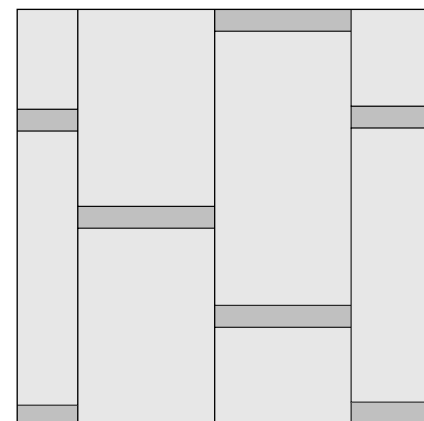

60X120 86%  (PAG. 16/17)  
10X60 14%

F.to nominale Nominal size	F.to reale (mm) Work size (mm)	Spessore Thickness	Tipologia imballo Type of packing	Pz/Imballo Pcs/Packing	Pz/Imballo Pcs/Packing	Mq/Scatola Sqm/Box	Kg/Scatola Kg/Box	Scatole/Imballo Box/Packing	Mq totali Sqm total	Kg/Imballo Kg/Packing	Kg totali Kg total
160x320 / 64"x128" rett.	1596,5x3195	7 mm	Cassa Crate	15	-	-	-	-	76,80	139	1.483
			Cavalletto container Container Rack pallet	36	-	-	-	-	184,32	180	3.406
120x240 / 48"x96" rett. / lapp.	1194x2390	7mm	Cavalletto Rack pallet	40	-	-	-	-	115,20	100	2.116
			Cassa Crate	20	-	-	-	-	57,60	100	1.108
			Cavalletto container Container Rack pallet	40	-	-	-	-	115,20	115	2.131
120x120 / 48"x48" rett. / lapp.	1194x1194	7 mm	Cavalletto Rack pallet	56	2	2,88	50,40	28	80,64	70	1.482
60x120 / 24"x48" rett. / lapp.	596x1194	7 mm	Pallet	81	3	2,16	36,00	27	58,32	-	988
10x60 / 4"x24" rett.	97,6x596	7 mm	Pallet	960	20	1,20	20,00	48	57,60	-	975
60x60 / 24"x24" rett.	596x596	9 mm	Pallet	120	3	1,08	21,20	40	43,20	-	868
30x30 / 12"x12" rett.	297x297	9 mm	Pallet	576	12	1,08	21,20	48	51,84	-	1038
10x60 / 4"x24" rett.	97,6x297	9 mm	Pallet	768	16	0,96	19,00	48	46,08	-	930
60x120 / 24"x48" rett.	600x1200	20 mm	Pallet	30	1	0,76	32,65	30	19,44	-	1000

I pezzi speciali, per effetto delle lavorazioni, possono presentare variazioni di tonalità. Due to working process, special trims may show variations in tonality. L'unità minima di vendita per tutti gli articoli (fondi, decori e pezzi speciali) è la scatola completa. The minimum sales quantity for all items (plain tiles, decorations and special trims) is one full box. I dati relativi agli imballi sono aggiornati al momento della stampa del catalogo e pertanto possono subire variazioni nel corso del tempo. Data referring to packaging have been update at time of printing; the actual data may be slightly different.

### LASTRE IN GRES PORCELLANATO A MASSA COLORATA FULL BODY COLORED PORCELAIN STONEWARE SLABS

CLASSIFICAZIONE SECONDO NORME UNI EN 14411 (ISO 13006) ALLEGATO G-Gruppo Bia  
CLASSIFICATION IN ACCORDANCE WITH UNI EN 14411 (ISO 13006) ANNEX G-Group Bia

PROPRIETÀ FISICO-CHIMICHE PHYSICAL-CHEMICAL PROPERTIES	NORMA NORM	VALORE PRESCRITTO DALLE NORME VALUE PRESCRIBED FROM THE NORMS	VALORE FLAVIKER FLAVIKER VALUE
RESISTENZA ALLO SCIVOLAMENTO SLIP RESISTANCE	B.C.R.A. C.A.	$\mu$ 0,19 SCIVOLosità PERICOLOSA - DANGEROUSLY SLIPPERY $0,20 < \mu < 0,39$ SCIVOLosità ECCESSIVA - EXCESSIVELY SLIPPERY $0,40 < \mu < 0,74$ ATTRITO SODDISFACENTE - SATISFACTORY GRIP $\mu$ 0,75 ATTRITO ECCELLENTE - EXCELLENT GRIP	>0,42
	B.C.R.A. G.B.		
	ASTM C 1028 (S.C.O.F.)	SLIP RESISTANT (> 0,60)	>0,60 DRY >0,60 WET
	DIN 51130	IN FUNZIONE DELL'AMBIENTE O DELLA ZONA DI LAVORO BASING ON THE ENVIRONMENT OR THE WORKING AREA	R10
	DIN 51097	-	A+B
	ANSI A 137-1:2012	$\geq 0,42$	>0,42

VARIAZIONE CROMATICA SHADE VARIATION	V2	 aspetto uniforme uniform appearance V1	 lieve variazione slight variation V2	 moderata variazione moderate variation V3	 forte variazione substantial variation V4
---	----	--	--	---	---

### FLAVIKER-PI.SA

S.S. 569 per Vignola, 226  
41014 Solignano di Castelvetro (Mo) Italy  
T +39 (0) 59 9752011  
F +39 (0) 59 9752010

flavikerpisa.it  
#flaviker



La riproduzione dei colori è approssimativa.  
Colour reproduction approximate.





