

Lo spazio si trasforma, la bellezza si fa ceramica. **Con "Wide Surfaces", Pastorelli dà il benvenuto ai grandi formati**, proponendo una gamma dinamica, studiata per offrire estrema versatilità progettuale al mondo dell'architettura contemporanea. Dal più grande formato 120x260 fino al più piccolo, "Wide Surfaces" incontra le esigenze innovative dell'abitare moderno, regalando agli spazi orizzonti infiniti.

The space changes, the beauty turns into ceramic. **With "Wide Surfaces", Pastorelli welcomes the big sizes**, introducing a dynamic range, studied to offer an extreme versatility in projects to the contemporary architectural world. With sizes ranging from 120x260 through to the smaller sizes, "Wide Surfaces" matches the innovative needs of the modern living, gratifying the spaces with limitless horizons.

L'espace se transforme, la beauté devient céramique. **Grâce à "Wide Surfaces", Pastorelli donne son bienvenu aux grands formats**, en proposant une gamme dynamique étudiée pour offrir une extrême adaptabilité au monde de l'architecture contemporaine. Du grand format 120x260 jusqu'au format le plus petit, "Wide Surfaces" rencontre les exigences innovatives du vivre moderne en offrant à tous espaces des horizons infinis.

Der Raum verwandelt, die Schönheit wird Keramik. **Mit "Wide Surfaces" begrüßt Pastorelli die großen Formate**, bietet eine vielfältige Produktpalette an, die für die meiste Flexibilität beim Design im heutigen Architekturbereich geeignet ist. Vom größten Format 120x260 bis zum kleinsten kommt "Wide Surfaces" die innovativen Anforderungen des modernen Wohnens und bietet den Räumen ein unendliches Horizont an.

120x260x0,65 cm: abbiamo i numeri per grandi idee.	2
120x260x0,65 cm: we've got what it takes to make designs great. 120x260x0,65 cm : nous avons les bons numéros pour de grandes idées. 120x260x0,65 cm: wir haben die Zahlen für große Ideen.	
Un riferimento per estetica e funzionalità.	4
A go-to collection for stunning looks and high functionality. Une référence pour l'esthétique et la fonctionnalité. Eine Referenz für Ästhetik und Zweckmäßigkeit.	
Concetti innovativi per progettare interni ed esterni.	6
Innovative concepts for interior and exterior designs. Des concepts innovants pour concevoir l'intérieur et l'extérieur. Innovative Konzepte für den Entwurf von Innen- und Außenbereichen.	
Destinato a grandi emozioni.	10
Creates great sensations. Destinées aux grandes-émotions. Für die angenehmsten Gefühle.	
I colori.	22
Colours. Les couleurs. Die Farben.	
I complementi di arredo.	32
Furnishing accessories. Les compléments d'ameublement. Das Einrichtungszubehör.	
Imballi.	34
Packaging. Emballage. Verpackungen.	
Informazioni tecniche	36
Technical information. Informations techniques. Technische Informationen.	

wi.sh

120x260

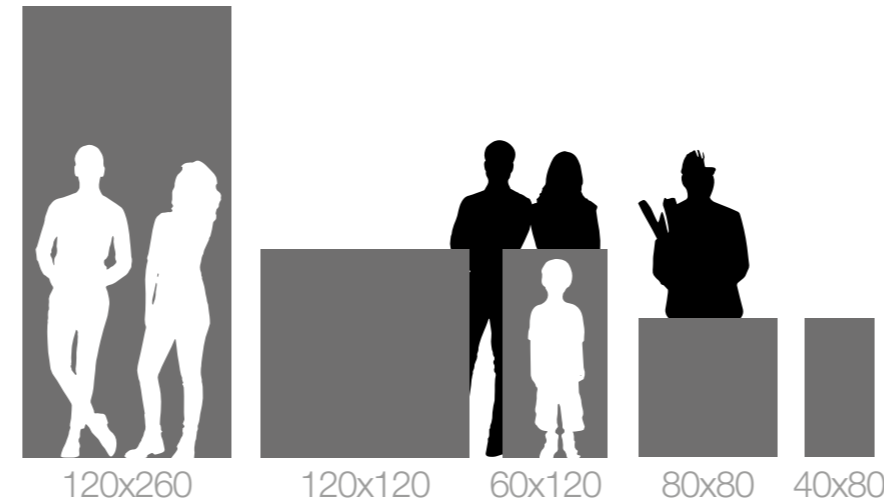

 pastorelli





120x260x0,65 cm: abbiamo i numeri per grandi idee.

120x260x0.65 cm: we've got what it takes to make designs great.
120x260x0,65 cm : nous avons les bons numéros pour de grandes idées.
120x260x0,65 cm: wir haben die Zahlen für große Ideen.

WI.SH aggiunge inedite potenzialità espressive alla forza del gres porcellanato. **120x260 cm** è la nuova grande superficie tecnologica di Pastorelli che risponde alla domanda di soluzioni innovative per l'architettura. Pavimenti e rivestimenti che definiscono un nuovo standard, ideale anche per le facciate esterne degli edifici. WI.SH rompe i tradizionali modelli della progettazione di interni e consente di realizzare nuove soluzioni per decorare lo spazio. L'estesa continuità di materia con **spessore 6,5 mm** permette di ricavare forme, anche irregolari, e di progettare o personalizzare elementi d'arredo coordinati ai pavimenti e rivestimenti.

WI.SH adds new creative potential to the technical strength of porcelain stoneware. **120x260 cm** is the new high-tech large slab option offered by Pastorelli to meet the need for innovative solutions in architecture. Coverings for floors and walls that set a new standard and are also ideal for building façades. WI.SH breaks out of the box to help users create new space-enhancing interior design solutions. Endless, seamless finishes and a **6.5 mm-thick** slab means designers can produce any number of shapes, even or uneven, and to design or customise furnishings that are coordinated with floors and walls.

6,5 mm

WI.SH ajoute des potentiels expressifs inédits à la force du grès cérame. **120x260 cm** est la nouvelle grande surface technologique de Pastorelli qui répond à la demande de solutions innovantes pour l'architecture. Des carrelages de sol et des revêtements muraux qui définissent un nouveau standard, également parfaits pour les façades extérieures des bâtiments. WI.SH rompt les modèles traditionnels de la conception intérieure et permet de réaliser de nouvelles solutions pour décorer l'espace. La continuité étendue de la matière d'une **épaisseur de 6,5 mm** permet d'obtenir des formes, également irrégulières, et de concevoir ou de personnaliser des éléments de décoration coordonnés au carrelage de sol et aux revêtements muraux.

WI.SH fügt der Kraft des Feinsteinzeugs neuartige Ausdrucksmöglichkeiten hinzu. **120x260 cm** ist die neue große technologische Oberfläche von Pastorelli, die dem Wunsch nach innovativen Lösungen für die Architektur nachkommt. Boden- und Wandbeläge, die einen neuen Standard bilden und auch für die Fassaden der Gebäude geeignet sind. WI.SH bricht mit den herkömmlichen Modellen des Entwurfs von Innenbereichen und ermöglicht die Verwirklichung neuer Lösungen zur Gestaltung des Raumes. Die weite Kontinuität der Materie mit einer **Stärke von 6,5 mm** ermöglicht es, Formen auch unregelmäßiger Art herzustellen oder zu den Boden- und Wandbelägen farblich passende Einrichtungselemente zu entwerfen bzw. kundenspezifisch zu gestalten.

Pareti: Silver . Silver Floral 120x260
Banco reception: Acciaio
Colonne: Acciaio
Porta: Silver
Tavolini "Bros-Large": Acciaio
Pavimento: Silver 120x120
Walls: Silver . Silver Floral 120x260
Reception counter: Acciaio
Columns: Acciaio
Door: Silver
"Bros-Large" Tables: Acciaio
Door: Silver 120x120
Murs : Silver . Silver Floral 120x260
Comptoir réception : Acciaio
Colonnes : Acciaio
Porte : Silver
Tables basses "Bros-Large" : Acciaio
Sol : Silver 120x120
Wände: Silver. Silver Floral 120x260
Empfangstheke: Acciaio
Säulen: Acciaio
Tür: Silver
Tische "Bros-Large": Acciaio
Bodenbelag: Silver 120x120



Rivestimenti ad altezza parete
Wall-height tiles.
Revêtements sur toute la hauteur du mur.
Verkleidungen in Wandhöhe.

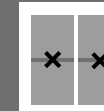

Ridotto numero di fughe, maggiore continuità di superficie
Fewer joints, greater surface continuity.
Nombre réduit de joints, continuité accrue de la surface.
Reduzierte Anzahl von Fugen, höhere Kontinuität der Oberfläche.



Soluzione estetica di pregio
Superior appearance.
Solution esthétique de valeur.
Exklusive ästhetische Lösung.



Resiste al calpestio
Tread-resistant.
Résiste au piétinement.
Trittfest.



Facile da posare
Easy to lay.
Facile à poser.
Leicht zu verlegen.



Un riferimento per estetica e funzionalità.

A go-to collection for stunning looks and high functionality.
Une référence pour l'esthétique et la fonctionnalité.
Eine Referenz für Ästhetik und Zweckmäßigkeit.

Le superfici **"wide surfaces"** mostrano caratteristiche di versatilità in ogni contesto di utilizzo. Sia in esterno che in interno si adattano alle problematiche specifiche dell'ambiente garantendo un effetto estetico esemplare.

Grazie a sistemi progettati per sostenere le lastre, con **WI.SH spessore 6,5 mm** è possibile realizzare **rivestimenti esterni** esposti sulle facciate degli edifici. Sia direttamente **a colla** con ancoraggi speciali fissati a parete, sia con sistemi evoluti di **"facciate ventilate"** caratterizzati da una intelaiatura che trattiene la lastra e produce vantaggi consistenti per l'efficienza dell'edificio.

The **"wide surfaces"** options offer supreme versatility in all settings and applications. Both indoors and outdoors, they address specific problems linked to the setting, guaranteeing outstanding aesthetics.

Thanks to the specially design slab support systems, **WI.SH 6.5 mm thickness** can be used as **external cladding** on building facades. It can be applied using either a **direct bonding adhesive** with special anchors fixed to the wall or advanced **curtain wall** systems featuring a retaining frame that holds the slab and offers substantial advantages in terms of building efficiency.

Les surfaces **"wide surfaces"** présentent des caractéristiques de polyvalence dans tout contexte d'utilisation. À l'extérieur et à l'intérieur, elles s'adaptent aux problèmes spécifiques de l'environnement en garantissant un effet esthétique exemplaire.

Grâce à des systèmes conçus pour soutenir les dalles, **WI.SH dans l'épaisseur 6,5 mm** permet de réaliser des **revêtements externes** exposés sur les façades des bâtiments. Directement **avec de la colle** et des ancres spéciaux fixés au mur, avec des systèmes évolués de **"façades ventilées"** caractérisés par une structure qui retient la dalle en produisant des avantages consistants pour l'efficacité du bâtiment.

Die Oberflächen **"Wide Surfaces"** sind in jedem Nutzungskontext vielseitig. Sowohl im Außen- als auch im Innenbereich passen sie sich den spezifischen Problematiken des Raumes an und garantieren einen beispielhaften ästhetischen Effekt.

Durch die zur Befestigung der Platten entworfenen Systeme, ist es mit **WI.SH in der Stärke 6,5 mm** möglich, **Außenverkleidungen** an den Fassaden der Gebäude herzustellen. Sowohl direkt **verklebt** mit an der Wand befestigten speziellen Verankerungen, als auch mit hochentwickelten Systemen für **"hinterlüftete Fassaden"**, die durch einen Rahmen gekennzeichnet sind, der die Platte hält und erhebliche Vorteile für die Effizienz des Gebäudes hervorruft.



Per interni ed esterni

For interiors and exteriors.
Pour l'intérieur et l'extérieur.
Für Innen- und Außenbereiche.



Resiste ai raggi UV

UV-resistant.
Résiste aux rayons UV.
Beständig gegenüber UV-Strahlen.



Aspetto originale immutabile

Long-lasting appearance.
Aspect d'origine immuable.
Unveränderliches ursprüngliches Aussehen.

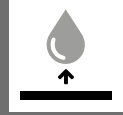

Impermeabile, protegge dall'acqua

Impermeable, waterproof.
Imperméable, protège de l'eau.
Undurchlässig, schützt vor dem Wasser.



Resistente al gelo

Frostproof.
Résistant au gel.
Frostbeständig.



Non teme gli sbalzi termici

Withstands sudden temperature changes.
Ne craint pas les écarts thermiques.
Leidet nicht unter Temperaturschwankungen.



Inattaccabile da muschi e muffe

Resistant to moss, mould and mildew.
Inattaquable par les mousses et les moisissures.
Kann nicht von Moosen und Schimmeln angegriffen werden.

Rivestimento in facciata: Acciaio
Facade cladding: Acciaio
Revêtement de façade : Acciaio
Verkleidung der Fassade: Acciaio



Top cucina: Acciaio - Targiere "Chef": Silver
Kitchen top: Acciaio - "Chef" chopping board: Silver
Plan de travail cuisine : Acciaio - Planche à découper "Chef" : Silver
Arbeitsplatte der Küche: Acciaio - Schneidbrett "Chef": Silver



Superficie igienica, ideale per alimenti

Hygienic surface, ideal for food.
Surface hygiénique, parfaite pour les aliments.
Hygienische Oberfläche, ideal für Nahrungsmittel.



Non si altera a contatto con fonti bollenti

Does not change upon contact with temperatures above boiling point.
Ne se détériore pas au contact des sources brûlantes.
Weist keine Veränderungen nach dem Kontakt mit Hitzequellen auf.



Resiste ai graffi

Scratchproof.
Résiste aux rayures.
Kratzfest.



Non si macchia

Stainproof.
Anti-tache.
Fleckt nicht.



Semplice da pulire

Easy to clean.
Facile à nettoyer.
Leicht zu reinigen.



Resiste ai prodotti chimici

Withstands chemicals.
Résiste aux produits chimiques.
Beständig gegenüber Chemikalien.



Non si usura

Wear-resistant.
Anti-usure.
Nutzt sich nicht ab.



Ignifugo

Fireproof.
Ignifuge.
Feuerfest.



Concetti innovativi per progettare interni ed esterni

Innovative concepts for interior and exterior designs.
Des concepts innovants pour concevoir l'intérieur et l'extérieur.
Innovative Konzepte für den Entwurf von Innen- und Außenbereichen.

LE LASTRE WI.SH SONO A TUTTI GLI EFFETTI UN MATERIALE INNOVATIVO PER IL DESIGN CONTEMPORANEO.

Non solo pavimenti e rivestimenti, ora puoi sviluppare ambienti sia per interni che esterni curati in ogni dettaglio.

Lo spessore ridotto e la semplicità con la quale è possibile produrre forme anche irregolari dalle lastre, permettono di personalizzare piani cucina, ante, porte, tavoli, lavandini e ogni complemento di arredo si voglia. LO PENSI E LO FAI.

WI.SH SLABS ARE ABSOLUTELY INNOVATIVE MATERIALS FOR CONTEMPORARY DESIGN.

Not just for floors and walls, users can now craft designs down to the smallest detail for both interiors and exteriors.

The slenderness of the material and the ease with which even irregular shapes can be created from the slabs, allow designers to produce customised kitchen tops, doors, tables, sinks and any other item of furniture desired.

SIMPLY DESIGN AND CREATE.

LES DALLES WI.SH SONT RÉALISÉES DANS UN MATÉRIAU ABSOLUMENT INNOVANT POUR LE DESIGN CONTEMPORAIN.

Pas seulement des carrelages de sol et des revêtements muraux, vous pouvez maintenant élaborer des espaces intérieurs et extérieurs soignés dans le moindre détail. L'épaisseur réduite et la simplicité avec laquelle on peut produire des formes mêmes irrégulières avec les dalles, permettent de personnaliser les plans de travail de cuisine, les vantaux, les portes, les tables, les lavabos et tout complément d'ameublement possible. VOUS LE CONCEVEZ ET LE RÉALISEZ.

DIE PLATTEN WI.SH SIND SOZUSAGEN EIN INNOVATIVES MATERIAL FÜR DAS MODERNE DESIGN.

Nicht allein Boden- und Wandbeläge, jetzt kann man Räume sowohl für die Innen- als auch die Außenbereiche entwerfen, die in allen Details gepflegt sind. Die geringe Stärke und die Einfachheit mit der auch unregelmäßige Formen aus den Platten gebildet werden können, ermöglichen es, Arbeitsplatten in der Küche, Schranktüren, Türen, Tische, Spülbecken und alle anderen Einrichtungsgegenstände nach Wunsch zu gestalten. DEINE IDEE VON DIR VERWIRKLICHT.



Facile da tagliare e forare

Easy to cut.
Facile à couper et à percer.
Leicht zu schneiden und zu bohren.

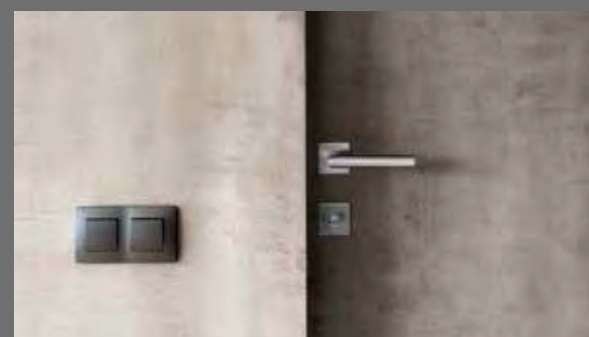

Prodotto leggero

Lightweight.
Produit léger.
Leichtes Produkt.

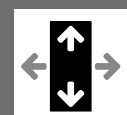

Facile da movimentare

Easy to handle.
Facile à manutentionner.
Leicht zu transportieren.

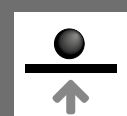

Superficie planare

Flat surface.
Surface plane.
Ebene Oberfläche.

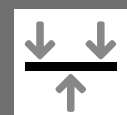

Resiste alla flessione

Withstands bending.
Résiste à la flexion.
Biegefest.

Rivestimento parete e porta: Acciaio 120x260
Pavimento: Antracite 120x120

Wall tiles and door cladding: Acciaio 120x260
Floor: Antracite 120x120

Revêtement mural et porte : Acciaio 120x260
Sol : Antracite 120x120.

Wandbelag und Türverkleidung: Acciaio 120x260
Fußboden: Antracite 120x120



Rivestimento: Ruggine 120x260
Pavimento: Beige 120x120
Vasi: Silver

Wall: Ruggine 120x260
Floor: Beige 120x120
Plant pots: Silver

Revêtement : Ruggine 120x260
Sol : Beige 120x120
Pots : Silver

Wandbelag: Ruggine 120x260.
Fußboden: Beige 120x120.
Vasen: Silver.



Piano del tavolo: Silver
Pavimento: Antracite 60x120

Table top: Silver
Floor: Antracite 60x120

Dessus de la table : Silver
Sol : Antracite 60x120

Tischplatte: Silver
Fußboden: Anthrazit 60x120

Top cucina: Ruggine
Ante cucina: Beige
Rivestimento parete: Beige
Pavimento: Ruggine 120x120

Kitchen top: Ruggine
Kitchen cabinet door: Beige
Wall tiling: Beige
Floor: Ruggine 120x120

Plan de travail cuisine : Ruggine
Portes de cuisine : Beige
Revêtement mural : Beige
Sol : Ruggine 120x120

Arbeitsplatte der Küche: Ruggine
Türen der Küchenschränke: Beige
Wandbelag: Beige
Fußboden: Ruggine 120x120

Rivestimento vasca: Ruggine
Pavimento: Ruggine 60x120

Bath tiling: Ruggine
Floor: Ruggine 60x120

Revêtement vasque : Ruggine
Sol : Ruggine 60x120

Verkleidung des Beckens: Ruggine
Fußboden: Ruggine 60x120





Destinato a grandi emozioni

Creates great sensations.
Destinées aux grandes-émotions.
Für die angenehmsten Gefühle.

La collezione WI.SH è composta da una gamma di formati e spessori definito per risolvere esigenze sia progettuali che tecniche:

- **6,5 mm** nel formato più grande 120x260 cm specializzato per rivestimenti interni e facciate esterne oltre che per coordinare i complementi di arredo. È adatto anche per pavimenti;
- **10 mm** nei formati 120x120, 60x120, 80x80 e 40x80 garantisce le migliori performance a pavimento anche in contesti sottoposti alle massime sollecitazioni. Ideale anche per soluzioni di rivestimento sia residenziali che pubbliche.

The WI.SH collection consists of a range of sizes and thicknesses devised to meet both design and technical requirements:

- **6.5 mm** in the largest size (120x260 cm) which is designed specifically for indoor and outdoor walls, as well as for coordinating furnishings. It is also suitable for floors;
- **10 mm** in the 120x120, 60x120, 80x80 and 40x80 sizes ensures the best flooring performance even in settings exposed to maximum stresses. Also ideal for use on both residential and public walls.

La collection WI.SH est constituée par une gamme de formats et d'épaisseurs définie pour résoudre toute exigence conceptuelle et technique:

- **6,5 mm** dans le grand format 120x260 cm spécialisé pour les revêtements intérieurs et les façades extérieures pour coordonner les compléments d'ameublement. Également indiqué pour les carrelages de sol ;
- **10 mm** dans les formats 120x120, 60x120, 80x80 et 40x80 il garantit les meilleures performances au sol également dans des contextes soumis à des contraintes extrêmes. Également parfait pour les solutions de revêtement résidentielles et publiques.

Die Kollektion WI.SH besteht aus einer Vielfalt von Formaten und Stärken zur Lösung von entwurfsbedingten und technischen Erfordernissen:

- **6,5 mm** im größten Format 120x260 cm speziell für die Verkleidung in Innenbereichen und auf Fassaden im Außenbereich, sowie zur farblichen Abstimmung des Einrichtungszubehörs. Auch als Bodenbeläge geeignet;
- **10 mm** in den Formaten 120x120, 60x120, 80x80 und 40x80 garantiert die besten Leistungen auf dem Fußboden auch unter den stärksten Belastungen. Ideal auch für Lösungen zur Verkleidung sowohl in Wohnbereichen als auch in öffentlichen Bereichen.

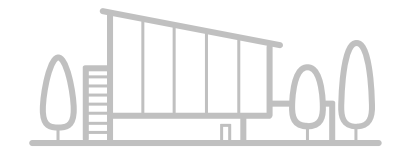

Centri commerciali.

Alberghi.

Spazi di aggregazione pubblica.

Scuole.

Aeroporti.

Stazioni.

Musei.

Centri sportivi.

Sale per conferenze.

Sale mostra.

Ristoranti.

Uffici.

Negozi.

Ambienti residenziali di pregio.

Cucine.

Soggiorni.

Sale da bagno residenziali e pubbliche.

Complementi d'arredo e design.

Commercial centres.

Hotels.

Leisure centres.

Schools.

Airports.

Train stations.

Museums.

Sport centres.

Conference halls.

Showrooms.

Restaurants.

Commercial offices.

Shops.

Luxury private places.

Kitchens.

Living rooms.

Private and public bathrooms.

Furnishing and design accessories.

Centres Commerciaux.

Hotels.

Espaces Publics.

Écoles.

Aéroports.

Gares.

Musées.

Centres sportifs.

Salles Conférences.

Salle Expo.

Restaurants.

Bureaux.

Boutiques.

Maison résidentiel.

Cuisines.

Séjours.

Salles de Bains.

Compléments d'ameublement et design.

Einkaufszentren.

Hotels.

Öffentliche Räume.

Schulen.

Flughäfen.

Bahnhöfe.

Museen.

Sportzentren.

Tagungsräume.

Ausstellungen.

Restaurants.

Büros.

Läden.

Luxus-privaträume.

Küchen.

Wohnzimmer.

Privat- und öffentliche Badzimmer.

Einrichtungszubehör und Designelemente.

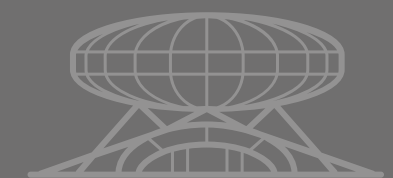



Rivestimento del "Gate": Silver
Banco del "Gate": Acciaio
Rivestimento colonne: Silver 120x260
Pavimento: Acciaio 120x120

Gate wall: Silver
Gate counter: Acciaio
Column tiling: Silver 120x260
Floor: Acciaio 120x120

Revêtement du "Gate" : Silver
Comptoir du "Gate" : Acciaio
Revêtement colonnes : Silver 120x260
Sol : Acciaio 120x120

Verkleidung des "Gate": Silver
Tisch des "Gate": Acciaio
Verkleidung der Säulen: Silver 120x260
Fußboden: Acciaio 120x120

Rivestimento: Silver 40x80 . Decoro Stripes Cold 40x40
Pavimento: Antracite 80x80 . Silver 80x80
Personalizzazione arredo: Antracite

Wall: Silver 40x80 . Decoro Stripes Cold 40x40
Floor: Antracite 80x80. Silver 80x80
Furniture customisation: Antracite

Revêtement : Silver 40x80 . Decoro Stripes Cold 40x40
Sol : Antracite 80x80 . Silver 80x80
Personnalisation mobilier : Antracite

Wandbelag: Silver 40x80. Decoro Stripes Cold 40x40
Fußboden: Antracite 80x80. Silver 80x80
Kundenspezifische Gestaltung der Einrichtung: Antracite

Beige 40x80 Dots





Rivestimento parete SX: Acciaio decoro Floral
Rivestimento parete DX: Silver decoro Floral
Parete Frontale: Silver Decoro pentagono
Cassetti mobile: Acciaio
Pavimento: Acciaio 120x120
Tavolini "Bros": Big, Medium, Small

LH wall: Acciaio, Floral decoration
RH wall: Silver, Floral decoration
Front wall: Silver, Pentagon decoration
Cupboard drawers: Acciaio
Floor: Acciaio 120x120
"Bros" tables: Big, Medium, Small

Revêtement mural GAU : Acciaio décor Floral
Revêtement mural DR : Silver décor Floral
Mur Frontal : Silver Décor Pentagone
Tiroirs meuble : Acciaio
Sol : Acciaio 120x120
Tables basses "Bros" : Big, Medium, Small

Wandbelag LI: Acciaio Dekor Floral
Wandbelag RE: Silver Dekor Floral
Vordere Wand: Silver Dekor Fünfeck
Kästen des Möbelstücks: Acciaio
Fußboden: Acciaio 120x120
Tische "Bros": Big, Medium, Small

Top cucina: Antracite
Ante cucina: Antracite
Rivestimento: Beige
Mensole: Beige
Pavimento: Beige 120x120

Kitchen top: Antracite
Kitchen cabinet door: Antracite
Wall: Beige
Shelves: Beige
Floor: Beige 120x120

Plan de travail cuisine : Antracite
Portes de la cuisine : Antracite
Revêtement mural : Beige
Étagères : Beige
Carrelage de sol : Beige 120x120

Arbeitsplatte der Küche: Antracite
Türen der Küchenschränke: Antracite
Verkleidung: Beige
Konsolen: Beige
Fußboden: Beige 120x120



Rivestimento parete SX: Beige 40x80 . Ruggine Dots 40x80
Rivestimento parete DX: Beige 40x80
Parete Doccia: Decoro Stripes Warm 40x40
Pavimento: Beige 80x80 . Ruggine 80x80
Rivestimento mobile bagno: Beige

LH wall: Beige 40x80 . Ruggine Dots 40x80
RH wall: Beige 40x80
Shower wall: Decoro Stripes Warm 40x40
Floor: Beige 80x80 . Ruggine 80x80
Washbasin unit tiling: Beige

Revêtement mural GAU : Beige 40x80 . Ruggine Dots 40x80
Revêtement mural DR : Beige 40x80
Mur Douche : Decoro Stripes Warm 40x40
Sol : Beige 80x80 . Ruggine 80x80
Revêtement meuble salle de bains : Beige

Wandbelag LI: Beige 40x80. Ruggine Dots 40x80
Wandbelag RE: Beige 40x80
Wand Duschkabine: Decoro Stripes Warm 40x40
Bodenbelag: Beige 80x80. Ruggine 80x80
Verkleidung des Badschranks: Beige

Rivestimento: Acciaio 40x80 Dots
Lavandino: Acciaio

Wall: Acciaio 40x80 Dots
Washbasin: Acciaio

Revêtement : Acciaio 40x80 Dots
Lavabo : Acciaio

Wandbelag: Acciaio 40x80 Dots
Spüle: Acciaio

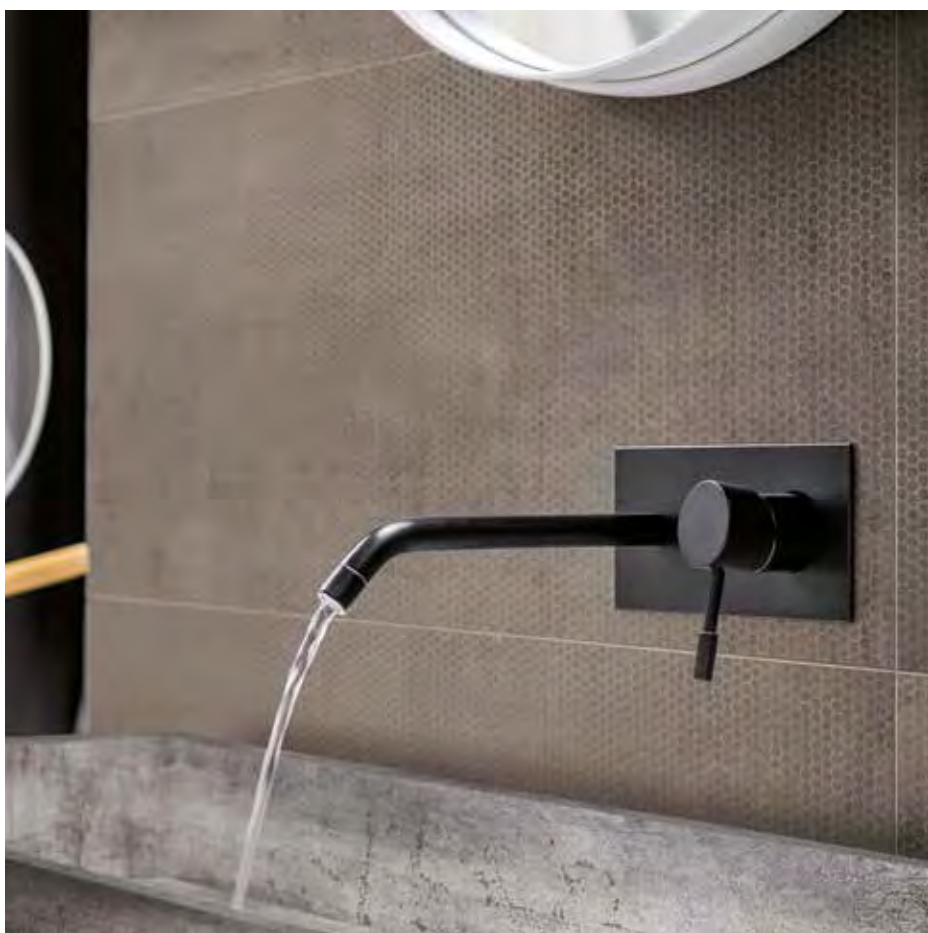



120x260 48"x102" 6,5MM
 120x120 48"x48" . 60x120 24"x48" 10MM
 80x80 32"x32" . 40x80 16"x32" 10MM



DIN 51130	DIN 51097	D.C.O.F.	B.C.R.A.	
			DRY	WET
R9	B	≥ 0,42	≥ 0,40	≥ 0,40

WI SILVER



6 FACCE DIFFERENTI
 6 different patterns.
 6 Faces différentes.
 6 verschiedene Seiten.



120x260 rett. 6,5 mm 185 185



3 FACCE DIFFERENTI
 3 different patterns.
 3 Faces différentes.
 3 verschiedene Seiten.



Decoro Floral 120x260 rett. 6,5 mm 200 200



120x120 rett. 10 mm 180 180



60x120 rett. 10 mm 173 173



Decoro Pentagono
 m² / pc: 0,29712
 6,5 mm

233 233 5

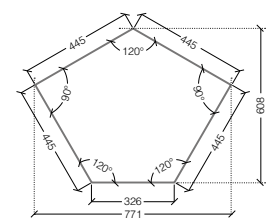

80x80 rett. 10 mm 161 161



40x80 rett. 10 mm 151 151

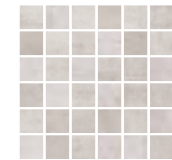

Mosaico
 30x30 (5x5)
 10 mm

195 195 5

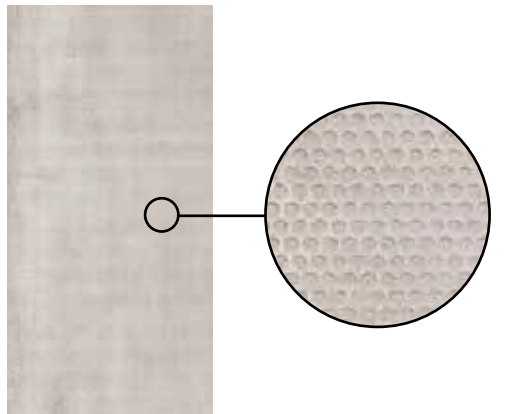

Decoro Dots 40x80 rett. 10 mm 173 173

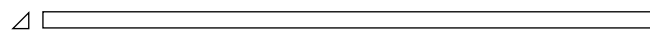

Listello Copriangolo 120 rett. 6,5 mm 201 6

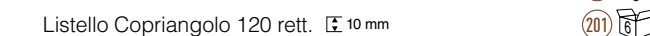

Listello Copriangolo 120 rett. 10 mm 201 6

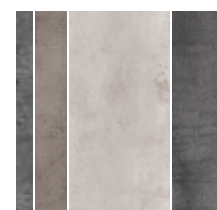

Decoro Stripes Cold 40x40 rett. 10 mm



189 189 5

PEZZI SPECIALI - Special trims - Pièces spéciales - Sonderstücke - Piezas especiales

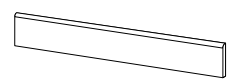

Battiscopa
 7x80 rett.
 10 mm

13 6



Battiscopa
 7x120 rett.
 10 mm

23 6



Gradone Assemblato
 3x33x120 rett.
 10 mm

273 6



Ang. Gradone Assemblato
 3x33x120 rett. (DX - SX)
 10 mm

271 6



120x260 48"x102" 6,5MM
 120x120 48"x48" . 60x120 24"x48" 10MM
 80x80 32"x32" . 40x80 16"x32" 10MM

DIN 51130 DIN 51097 D.C.O.F. B.C.R.A.

		DRY	WET
R9	B	≥ 0,42	≥ 0,40

WI ACCIAIO



6 FACCE DIFFERENTI
 6 different patterns.
 6 Faces différentes.
 6 verschiedene Seiten.



120x260 rett. 6,5 mm 185 185



3 FACCE DIFFERENTI
 3 different patterns.
 3 Faces différentes.
 3 verschiedene Seiten.



Decoro Floral 120x260 rett. 6,5 mm 200 200



120x120 rett. 10 mm 180 180



60x120 rett. 10 mm 173 173

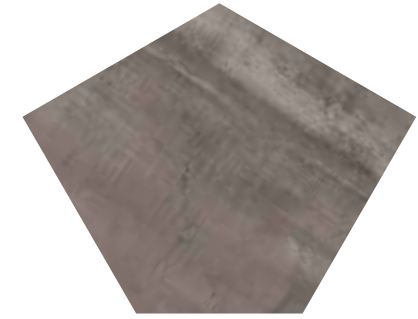

Decoro Pentagono
 m² / pc: 0,29712
 6,5 mm

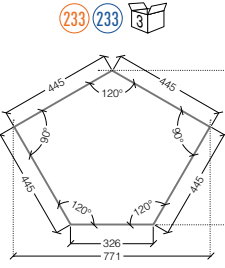

233 233 5

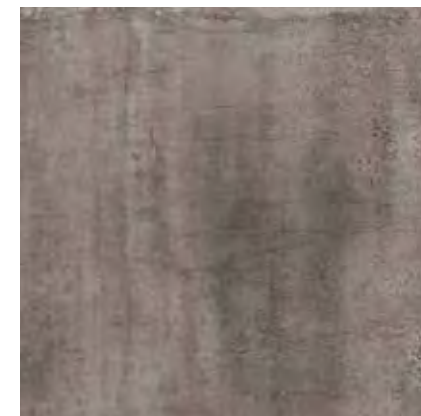

80x80 rett. 10 mm 161 161



40x80 rett. 10 mm 151 151

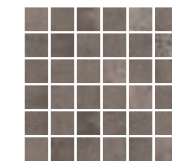

Mosaico
 30x30 (5x5)
 10 mm

195 195 5

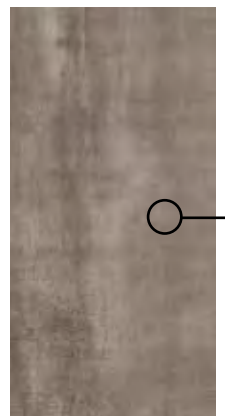

Decoro Dots
 40x80 rett. 10 mm 173 173

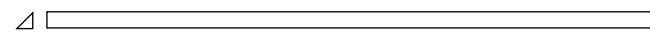
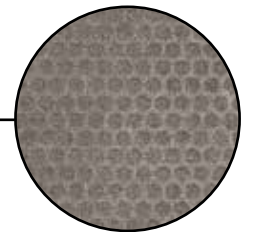

Listello Copriangolo 120 rett. 6,5 mm 201 201 6

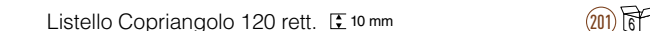

Listello Copriangolo 120 rett. 10 mm 201 201 6

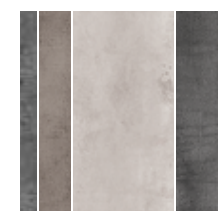

Decoro Stripes Cold 40x40 rett. 10 mm 189 189 3

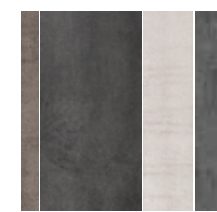

PEZZI SPECIALI - Special trims - Pièces spéciales - Sonderstücke - Piezas especiales

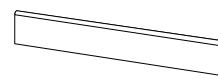

Battiscopa
 7x80 rett.
 10 mm

13 10



Battiscopa
 7x120 rett.
 10 mm

23 6



Gradone Assemblato
 3x33x120 rett.
 10 mm

273 1



Ang. Gradone Assemblato
 3x33x120 rett. (DX - SX)
 10 mm

271 2

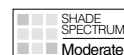

120x260 48"x102" 6,5MM
 120x120 48"x48" . 60x120 24"x48" 10MM
 80x80 32"x32" . 40x80 16"x32" 10MM

DIN 51130 DIN 51097 D.C.O.F. B.C.R.A.



		DRY	WET
R9	B	≥ 0,42	≥ 0,40

WI ANTRACITE



6 FACCE DIFFERENTI

6 different patterns.
 6 Faces différentes.
 6 verschiedene Seiten.

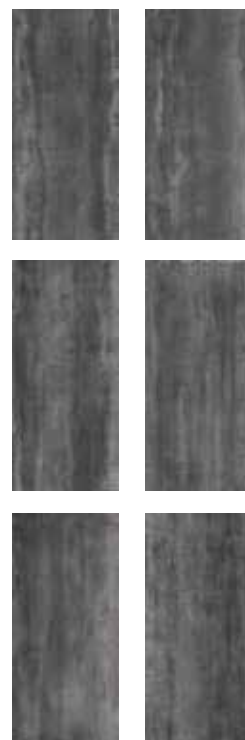

120x260 rett. 6,5 mm 185 185



3 FACCE DIFFERENTI

3 different patterns.
 3 Faces différentes.
 3 verschiedene Seiten.



Decoro Floral 120x260 rett. 6,5 mm 200 200



120x120 rett. 10 mm 180 180



60x120 rett. 10 mm 173 173

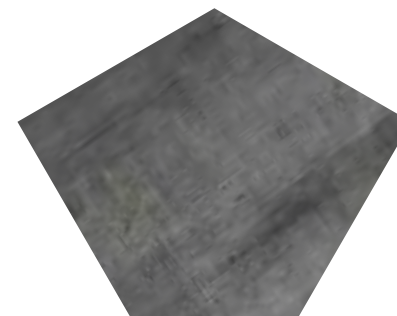

Decoro Pentagono
 m² / pc: 0,29712

6,5 mm

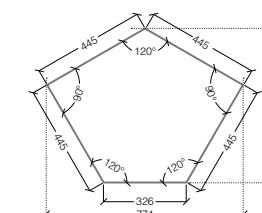

80x80 rett. 10 mm 161 161



40x80 rett. 10 mm 151 151

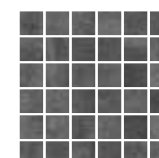

Mosaico
 30x30 (5x5)
 10 mm

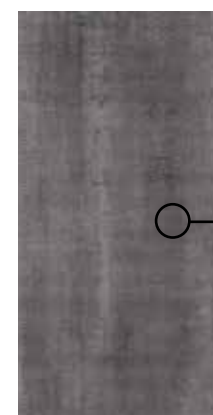

Decoro Dots 40x80 rett. 10 mm 173 173

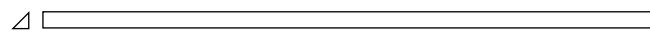
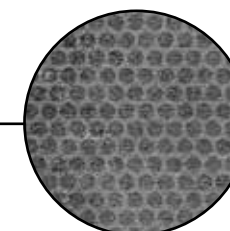

Listello Copriangolo 120 rett. 6,5 mm 201 201

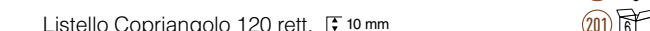

Listello Copriangolo 120 rett. 10 mm 201 201

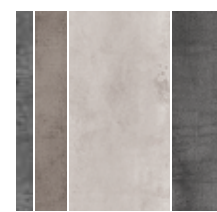

Decoro Stripes Cold 40x40 rett. 10 mm 189 189

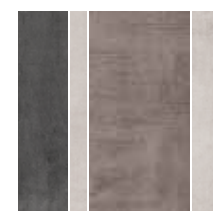
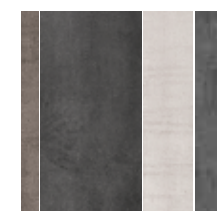

PEZZI SPECIALI - Special trims - Pièces spéciales - Sonderstücke - Piezas especiales



Battiscopa
 7x80 rett.
 10 mm

13



Battiscopa
 7x120 rett.
 10 mm

23



Gradone Assemblato
 3x33x120 rett.
 10 mm

273



Ang. Gradone Assemblato
 3x33x120 rett. (DX - SX)
 10 mm

271

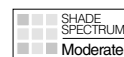

120x260 48"x102" 6,5MM
 120x120 48"x48" . 60x120 24"x48" 10MM
 80x80 32"x32" . 40x80 16"x32" 10MM

DIN 51130 DIN 51097 D.C.O.F. B.C.R.A.



R9	B	≥ 0,42	≥ 0,40	≥ 0,40
			DRY	WET

WI BEIGE



6 FACCE DIFFERENTI
 6 different patterns.
 6 Faces différentes.
 6 verschiedene Seiten.



120x260 rett. 6,5 mm 185 185



3 FACCE DIFFERENTI
 3 different patterns.
 3 Faces différentes.
 3 verschiedene Seiten.



Decoro Floral 120x260 rett. 6,5 mm 200 200



120x120 rett. 10 mm 180 180



60x120 rett. 10 mm 173 173



Decoro Pentagono
 m² / pc: 0,29712
 6,5 mm

233 233 5

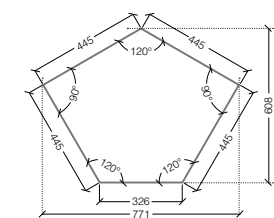

80x80 rett. 10 mm 161 161



40x80 rett. 10 mm 151 151



Mosaico
 30x30 (5x5)
 10 mm

195 195 5

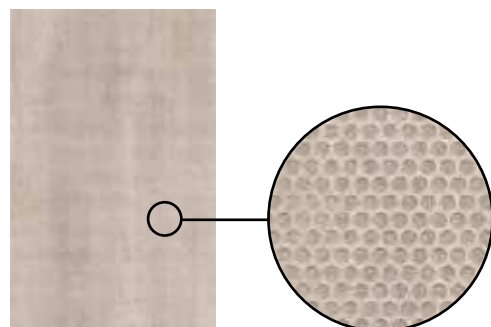

Decoro Dots 40x80 rett. 10 mm 173 173

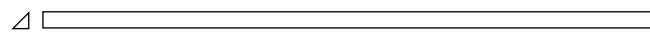

Listello Copriangolo 120 rett. 6,5 mm 201 6

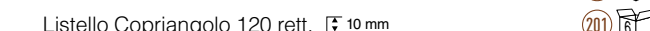

Listello Copriangolo 120 rett. 10 mm 201 6

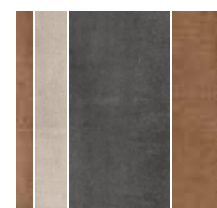

Decoro Stripes Warm 40x40 rett. 10 mm

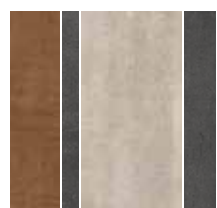
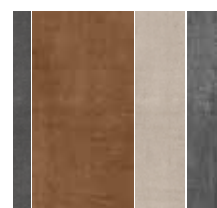

189 189 5

PEZZI SPECIALI - Special trims - Pièces spéciales - Sonderstücke - Piezas especiales

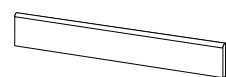

Battiscopa
 7x80 rett.
 10 mm

13 10



Battiscopa
 7x120 rett.
 10 mm

23 6



Gradone Assemblato
 3x33x120 rett.
 10 mm

273 1



Ang. Gradone Assemblato
 3x33x120 rett. (DX - SX)
 10 mm

271 2

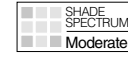

120x260 48"x102" 6,5MM
 120x120 48"x48" . 60x120 24"x48" 10MM
 80x80 32"x32" . 40x80 16"x32" 10MM



DIN 51130	DIN 51097	D.C.O.F.	B.C.R.A.	
			DRY	WET
R9	B	≥ 0,42	≥ 0,40	≥ 0,40

WI RUGGINE



6 FACCE DIFFERENTI
 6 different patterns.
 6 Faces différentes.
 6 verschiedene Seiten.



120x260 rett. 6,5 mm 185 185



3 FACCE DIFFERENTI
 3 different patterns.
 3 Faces différentes.
 3 verschiedene Seiten.



Decoro Floral 120x260 rett. 6,5 mm 200 200



120x120 rett. 10 mm 180 180



60x120 rett. 10 mm 173 173



Decoro Pentagono
 m² / pc: 0,29712
 6,5 mm

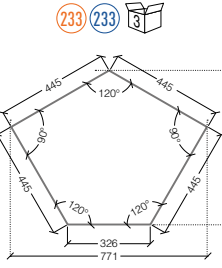

233 233 5

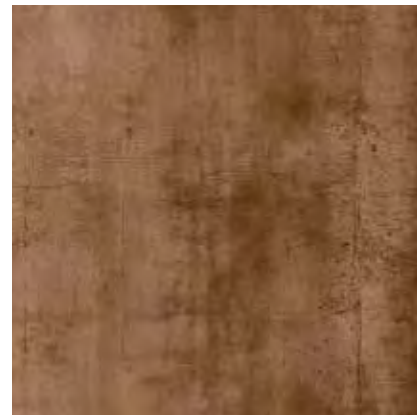

80x80 rett. 10 mm 161 161



40x80 rett. 10 mm 151 151

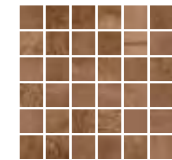

Mosaico
 30x30 (5x5)
 10 mm

195 195 5



Decoro Dots 40x80 rett. 10 mm 173 173

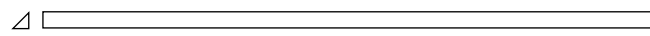
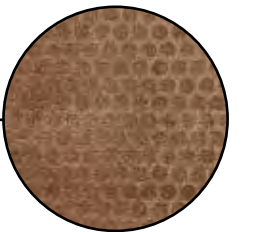

Listello Copriangolo 120 rett. 6,5 mm 201 6

Listello Copriangolo 120 rett. 10 mm 201 6



Decoro Stripes Warm 40x40 rett. 10 mm



189 189 5

PEZZI SPECIALI - Special trims - Pièces spéciales - Sonderstücke - Piezas especiales

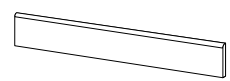

● Battiscopa
 7x80 rett.
 10 mm

13 6



● Battiscopa
 7x120 rett.
 10 mm

23 6



● Gradone Assemblato
 3x33x120 rett.
 10 mm

273 6



● Ang. Gradone Assemblato
 3x33x120 rett. (DX - SX)
 10 mm

271 6

I complementi di arredo

Furnishing accessories - Les compléments d'ameublement - Das Einrichtungszubehör

Tavolo - Table - Table - Tisch

STYLE



Piani personalizzabili con le lastre WI.SH 120x260 a fondo neutro o decoro "Floral".

Custom table tops can be produced using 120x260 WI.SH slabs with a neutral background or the "Floral" decoration.
Dessus à personnaliser avec les dalles WI.SH 120x260 à fond neutre ou avec décor "Floral".
Flächen kundenspezifisch gestaltbar mit den Platten WI.SH 120x260 mit neutralem Untergrund oder Dekor Floral.

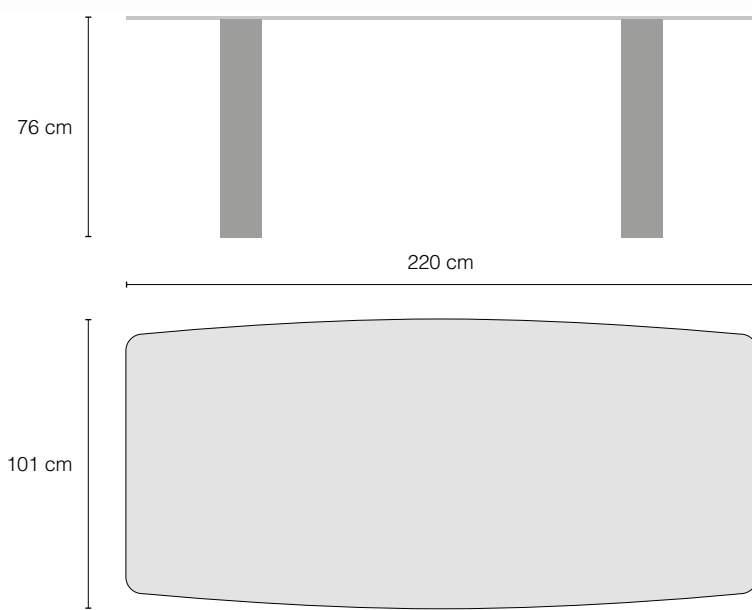

Tavolo - Table - Table - Tisch

CITY

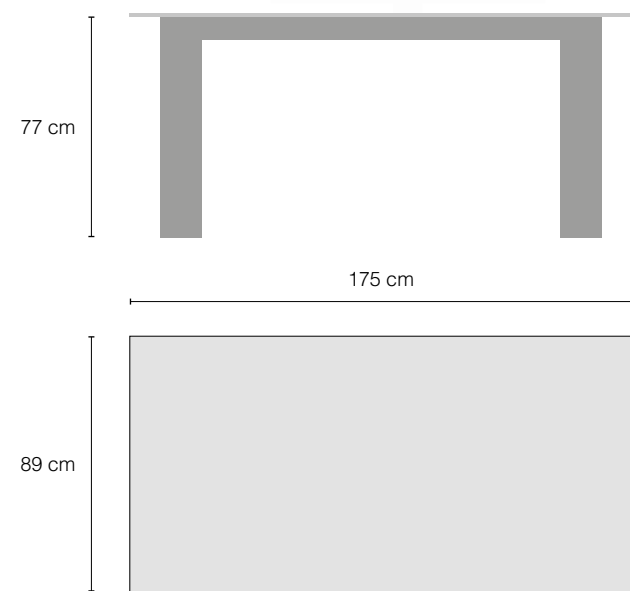

Tavolini - Tables - Tables basses - Tische

BROS



Piani personalizzabili con le lastre WI.SH 120x260 a fondo neutro o decoro "Floral".
Custom table tops can be produced using 120x260 WI.SH slabs with a neutral background or the "Floral" decoration.
Dessus à personnaliser avec les dalles WI.SH 120x260 à fond neutre ou avec décor "Floral".
Flächen kundenspezifisch gestaltbar mit den Platten WI.SH 120x260 mit neutralem Untergrund oder Dekor Floral.

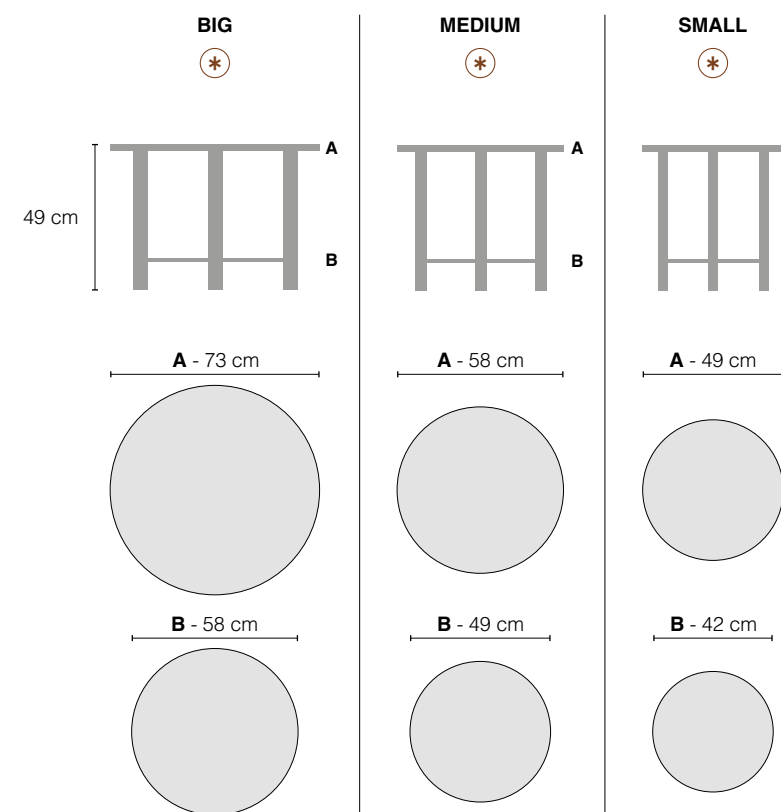

Tagliere - Chopping board - Planche à découper - Schneidbretter

CHEF



Disponibile nei colori e decori WI.SH.
Available in the WI.SH colours and decorations.
Disponibile dans les couleurs et les décors WI.SH.
Erhältlich in den Farben und Dekors WI.SH.

Su richiesta possono essere realizzati pezzi personalizzati previo studio di fattibilità. Nell'immagine alcuni esempi.

Upon request, personalised pieces can be made, subject to a feasibility study. A few examples in the image.

Sur demande, des pièces personnalisables peuvent être réalisées après une étude de faisabilité. Voici quelques exemples sur l'image.

Auf Anfrage können nach vorheriger Machbarkeitsstudie individuell gestaltete Teile hergestellt werden. Im Bild einige Beispiele.



Imballi

Packaging - Emballage - Verpackungen

Le lastre Pastorelli in formato 120x260 cm sono accuratamente imballate in casse o cavalletti per un trasporto sicuro e protetto. Gli imballi sono realizzati in legno termo trattato IPPC FAO che ne permette l'exportazione verso tutti i Paesi. L'imballo standard è la cassa per il trasporto in orizzontale, mentre i cavalletti sono utilizzati principalmente per ottimizzare il carico dei container.

The Pastorelli 120x260 cm / 48"x102" in slabs are carefully packaged into crates or racks for safe and protected transportation. The packaging is made of IPPC FAO heat-treated wood, which means it can be exported to all countries. The standard packaging is the horizontal transport crate, while racks are mainly used to optimise container loads.

Les dalles Pastorelli de format 120x260 cm sont soigneusement emballées dans des caisses ou chevalets pour un transport sûr et protégé. L'emballage est en bois traité thermiquement IPPC FAO ce qui permet une exportation vers tous les pays. L'emballage standard est la caisse de transport horizontal, tandis que les chevalets sont principalement utilisés pour optimiser le chargement des conteneurs.

Die Pastorelli-Platten im Format 120x260 cm werden zum sicheren und geschützten Transport sorgfältig in Kisten oder auf Böcken verpackt. Die Verpackungen bestehen aus wärmebehandeltem IPPC FAO-Holz, das in alle Länder exportiert werden kann. Die Standardverpackung ist die Kiste für den waagerechten Transport, während die Böcke hauptsächlich zur Optimierung der Ladung von Containern eingesetzt werden.

Cassa

Crate - Caisse - Kiste

Le lastre Pastorelli posizionate all'interno delle casse vengono tenute ferme da elementi in polistirolo per minimizzare i rischi di rottura durante il trasporto. Un nylon termoretraibile copre le lastre per tenerle pulite e permetterle anche lo stoccaggio all'esterno.

Pastorelli slabs positioned into crates are secured by material in polystyrene to minimise the risk of breakage during transport. Heat-shrinkable nylon covers the slabs to keep them clean and also allow them to be stored outside.

Les dalles Pastorelli placées à l'intérieur des caisses sont maintenues en place par des éléments en polystyrène afin de minimiser les risques de casse pendant le transport. Un film plastique couvre les dalles pour les garder propres et leur permettre d'être stockées aussi à l'extérieur.

Die Pastorelli-Platten in den Kisten werden Anhand von Styropor fixiert, um die Bruchgefahr während des Transports zu minimieren. Eine Kunststoff-Schrumpffolienverpackung deckt die Platten ab, um sie vor Schmutz zu schützen, und die Ware auch im Freien lagern zu können.

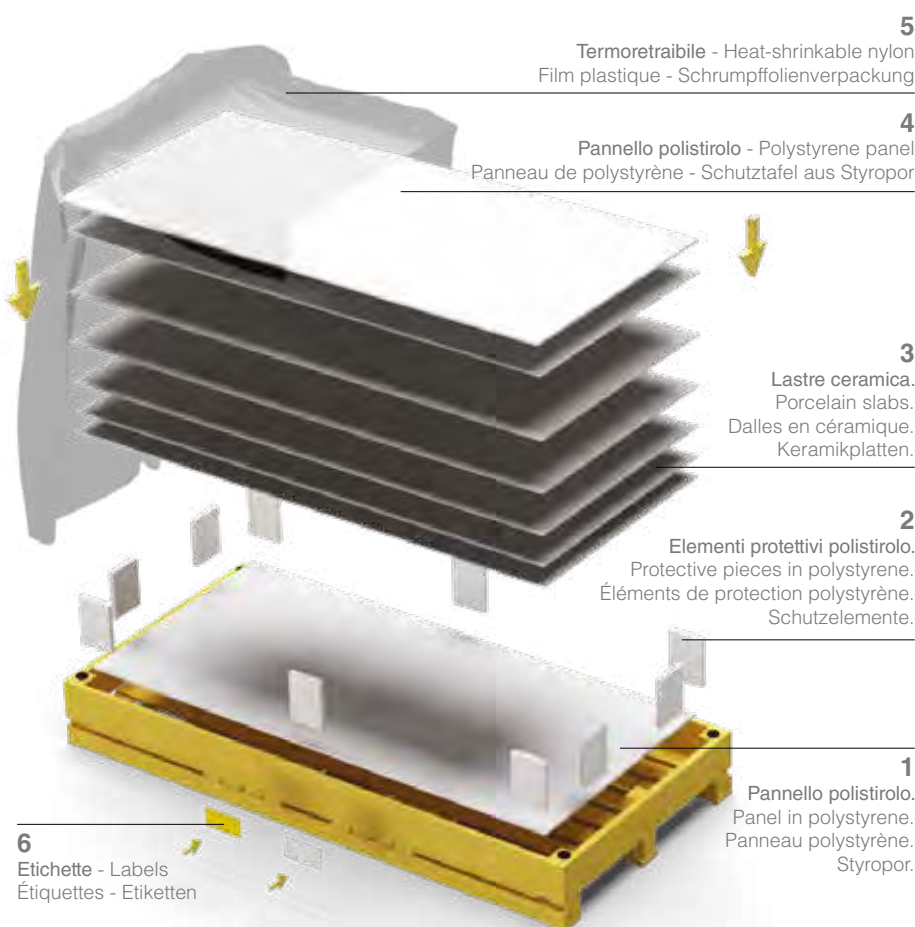

CASSA . Crate . Caisse . Kiste				
Dimensioni Dimensions Dimensions Abmessungen	Pezzi Pieces Pièces Stück	m ²	Peso lordo Gross weight Poids brut Bruttogewicht	Tara Tare Tare Tara-Gewicht
284 x 135 x h.34 cm	22	68,64	1233	86

Per la movimentazione delle casse sono necessari carrelli elevatori con portata massima di almeno **2,5 ton**.

For handling crates, forklifts are required with a maximum load capacity of at least **2.5 ton**.

Pour la manipulation des caisses, des chariots élévateurs d'une capacité maximale d'au moins **2,5 tonnes** sont nécessaires.

Für die Beförderung der Kisten sind Gabelstapler mit einer maximalen Tragfähigkeit von mindestens **2,5 Tonnen** erforderlich.

Dettaglio dell'imballaggio in cassa.
Details on packaging on racks.
Dettaglio dell'imballaggio in cassa.
Dettaglio dell'imballaggio in cassa.

Cavalletto

Rack - Chevalet - Bock

In alcune situazioni, soprattutto per la spedizione di container, può essere utile posizionare le lastre su cavalletti. Le lastre vengono saldamente fermate con reggette; è fondamentale assicurare l'ancoraggio e la stabilità dell'intero cavalletto durante il trasporto.

In some situations, especially when shipping in containers, it can be useful to place the slabs onto racks. The slabs are firmly secured with straps; ensuring the anchoring and stability of the full rack during transport is essential.

Dans certaines situations, en particulier pour l'expédition par conteneur, il peut être utile de placer les dalles sur des chevalets. Les dalles sont fermement fixées à l'aide de sangles; il est essentiel d'assurer l'ancrage et la stabilité de l'ensemble du chevalet pendant le transport.

In einigen Situationen, insbesondere beim Versand in Containern, kann es nützlich sein, die Platten auf Böcken zu verpacken um Platz zu sparen. Die Platten werden fest mit Umreifungsbänder gesichert. Es ist von grundlegender Bedeutung, die Verankerung und die Stabilität des gesamten Bocks während des Transports sicherzustellen.

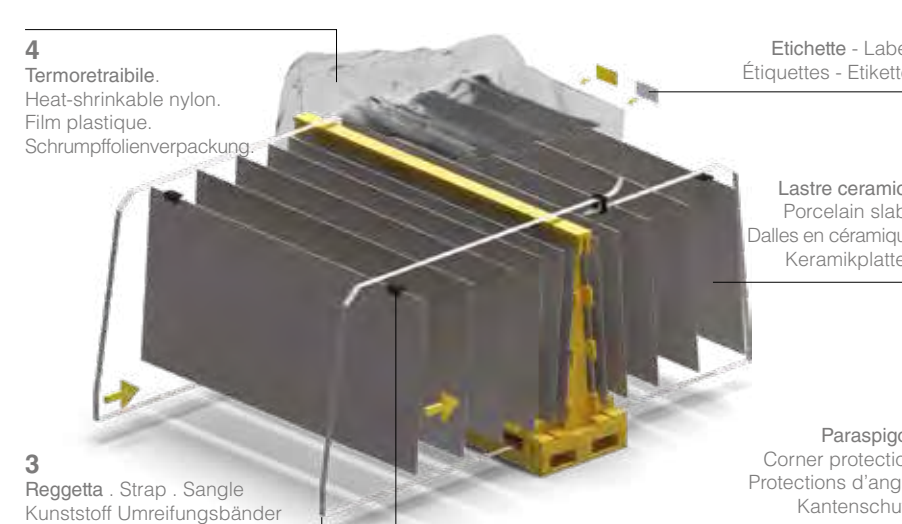
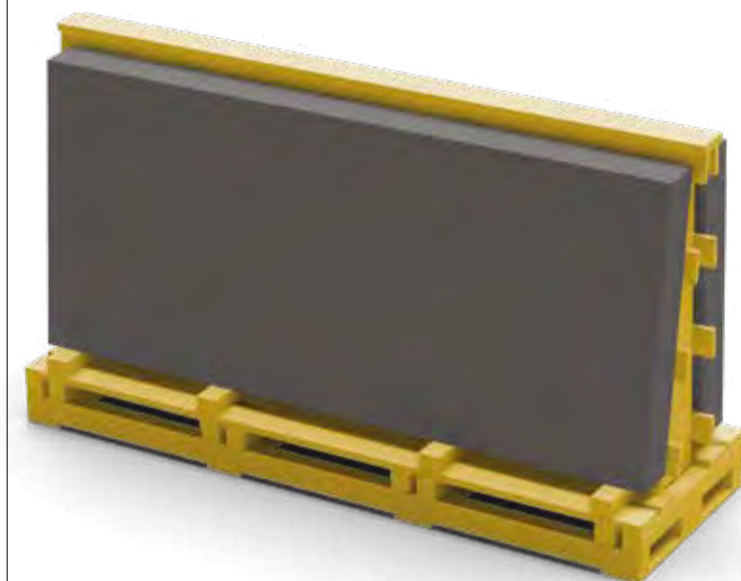

CAVALLETTO . Rack . Chevalet . Bock: HEAVY				
Dimensioni Dimensions Dimensions Abmessungen	Pezzi Pieces Pièces Stück	m ²	Peso lordo Gross weight Poids brut Bruttogewicht	Tara Tare Tare Tara-Gewicht
270 x 75 x h.161 cm	44	137,28	2425	131

Per la movimentazione dei cavalletti "HEAVY" sono necessari carrelli elevatori con forche di lunghezza minima **200 cm** e con portata massima di almeno **4,5 ton**.

For handling "HEAVY" racks forklifts are required with forks in a minimum length of **200 cm / 80 in** and a maximum load capacity of at least **4.5 ton**.

Pour la manipulation des chevalets « **HEAVY** » des chariots élévateurs sont nécessaires avec des fourches d'une longueur minimale de **200 cm** et avec une portée maximale d'au-moins **4,5 tonnes**.

Für die Beförderung von Böcken in der „**HEAVY**“- Version sind Gabelstapler mit Gabeln mit einer Mindestlänge von **200 cm** und einer maximalen Tragfähigkeit von mindestens **4,5 Tonnen** erforderlich.

CAVALLETTO . Rack . Chevalet . Bock: LIGHT				
Dimensioni Dimensions Dimensions Abmessungen	Pezzi Pieces Pièces Stück	m ²	Peso lordo Gross weight Poids brut Bruttogewicht	Tara Tare Tare Tara-Gewicht
270 x 75 x h.161 cm	22	68,64	1278	131

Per la movimentazione dei cavalletti "LIGHT" sono necessari carrelli elevatori con forche di lunghezza minima **200 cm** e con portata massima di almeno **2,5 ton**.

For handling "LIGHT" racks forklifts are required with forks in a minimum length of **200 cm / 80 in** and a maximum load capacity of at least **2.5 ton**.

Pour la manipulation des chevalets « **LIGHT** » des chariots élévateurs sont nécessaires avec des fourches d'une longueur minimale de **200 cm** et avec une portée maximale d'au-moins **2,5 tonnes**.

Für die Beförderung von Böcken in der „**LIGHT**“-Version sind Gabelstapler mit Gabeln mit einer Mindestlänge von **200 cm** und einer maximalen Tragfähigkeit von mindestens **2,5 Tonnen** erforderlich.







CARATTERISTICHE TECNICHE TECHNICAL CHARACTERISTICS CARACTERISTIQUES TECHNIQUES TECHNISCHE EINGESCHAFTEN	METODO DI PROVA TEST METHOD METHODE D'ESSAI PRÜFMETHODEN	EN 14411: 2016 - APPENDICE G - REQUISITI PER GRUPPO BLA EN 14411: 2016 - ANNEXE G - REQUISITS FOR BLA - G1 EN 14411: 2016 - ANNEXE G - EXIGENCES DU GROUPE BA EN 14411: 2016 - ANHANG G - ANFORDERUNGEN GRUPPE BA	VALORE MEDIO CONFORMITÀ AVERAGE VALUE FOR SLAB VALEUR MOYENNE CONFORMITÉ DURCHSCHNITTSWERT ANFORDERUNGEN	
LUNGHEZZA E LARGHEZZA LENGHT AND WIDTH LONGUEUR ET LARGEUR LÄNGE UND BREITE	ISO 10545-2	± 0,6%	± 2,0 mm	CONFORME. COMPLIANT. CONFORME. ERFÜLLT.
RETTILINEITÀ DEGLI SPIGOLI STRAIGHTNESS OF SIDES RECTITUDE DES BORDS GERADHEIT DER KANTEN	ISO 10545-2	± 0,5%	± 1,5 mm	CONFORME. COMPLIANT. CONFORME. ERFÜLLT.
ORTOGONALITÀ RECTANGULARITY ORTHOGONALITE RECHTWINKELIGKEIT	ISO 10545-2	± 0,5%	± 2,0 mm	CONFORME. COMPLIANT. CONFORME. ERFÜLLT.
PLANARITÀ - CURVATURA DEL CENTRO FLATNESS - CENTRE CURVATURE PLANEITE - COURBURE CENTRALE EBENÄCHIGKEIT - MITTELPUNKTWÖLBUNG	ISO 10545-2	± 0,5%	± 2,0 mm	CONFORME. COMPLIANT. CONFORME. ERFÜLLT.
PLANARITÀ - CURVATURA DELLO SPIGOLO FLATNESS - EDGE CURVATURE PLANEITE - COURBURE DU BORD EBENÄCHIGKEIT - KANTENWÖLBUNG	ISO 10545-2	± 0,5%	± 2,0 mm	CONFORME. COMPLIANT. CONFORME. ERFÜLLT.
PLANARITÀ - SVERGOLAMENTO FLATNESS - WARPAGE PLANEITE - TORSION EBENÄCHIGKEIT - WINDSCHLEIFE	ISO 10545-2	± 0,5%	± 2,0 mm	CONFORME. COMPLIANT. CONFORME. ERFÜLLT.
SPESSORE THICKNESS ÉPAISSEUR STÄRKE	ISO 10545-2	± 5%	± 0,5 mm	CONFORME. COMPLIANT. CONFORME. ERFÜLLT.
QUALITÀ DELLA SUPERFICIE SURFACE QUALITY QUALITÉ DE LA SURFACE OBERÄCHEN MANGELFREIHEIT	ISO 10545-2	MINIMO MINIMUM MINIMUM MINIMUM 95%		CONFORME. COMPLIANT. CONFORME. ERFÜLLT.
ASSORBIMENTO D'ACQUA WATER ABSORPTION ABSORPTION D'EAU WASSERAUFNAHME	ISO 10545-3	MASSIMO MAXIMUM MAXIMUM MAXIMUM 0,5%		CONFORME. COMPLIANT. CONFORME. ERFÜLLT.
RESISTENZA ALLA FLESSIONE RESISTANCE À LA EXION RESISTANCE À LA FLEXION BIEGEFESTIGKEIT	ISO 10545-4	> 35 N/mm²		CONFORME. COMPLIANT. CONFORME. ERFÜLLT.
FORZA DI ROTTURA BREAKING STRENGTH FORCE DE RUPTURE BRUCHLAST	ISO 10545-4	> 700 N		CONFORME. COMPLIANT. CONFORME. ERFÜLLT.
RESISTENZA AGLI SBALZI TERMICI THERMAL SHOCK RESISTANCE RÉSISTANCE AUX ÉCARTS DE TEMPÉRATURE TEMPERATURWECHSELBESTÄNDIGKEIT	ISO 10545-9	Pass		CONFORME. COMPLIANT. CONFORME. ERFÜLLT.
DILATAZIONE ALL'UMIDITÀ MOISTURE EXPANSION DILATATION À L'HUMIDITÉ FEUCHTEDEHNUNG	ISO 10545-10	VALORE DICHIARATO. DECLARED VALUE. VALEUR DECLARÉE. DECLARIERTER WERT.	~ 0,04 mm/m	
RESISTENZA AL CAVILLO CRAZING RESISTANCE RÉSISTANCE À LA FAILLE WIDERSTAND GEGEN GLASURRISSE	ISO 10545-11	Pass		CONFORME. COMPLIANT. CONFORME. ERFÜLLT.
RESISTENZA AL GELO FROST RESISTANCE RÉSISTANCE AU GEL FROSTBESTÄNDIGKEIT	ISO 10545-12	Pass		CONFORME. COMPLIANT. CONFORME. ERFÜLLT.
RESISTENZA AI PRODOTTI CHIMICI CHEMICAL RESISTANCE RÉSISTANCE AUX PRODUITS CHIMIQUES CHEMIKALIENBESTÄNDIGKEIT	ISO 10545-13	CLASSE: CLASS: GB CLASSE: CLASSE: MINIMO MINIMUM MINDESTWERT		CONFORME. COMPLIANT. CONFORME. ERFÜLLT.
RESISTENZA ALLE MACCHIE STAIN RESISTANCE RÉSISTANCE AUX TACHES FLECKBESTÄNDIGKEIT	ISO 10545-14	CLASSE: CLASS: 3 CLASSE: CLASSE: MINIMO MINIMUM MINDESTWERT		CONFORME. COMPLIANT. CONFORME. ERFÜLLT.
CESSIONE DI PIOMBO E CADMIO EXCHANGE LEAD-CADMIUM VENTE DE PLOMB ET DE CADMIUM BLEI- UND CADMIUMABGABE	ISO 10545-15	VALORE DICHIARATO. DECLARED VALUE. VALEUR DECLARÉE. DECLARIERTER WERT.	Pb <0,1 mg/dm² Cd <0,01 mg/dm²	
RESISTENZA AL FUOCO - PAVIMENTO FIRE REACTION - FLOOR RÉSISTANCE AU FEU - PLANCHER BRANDVERHALTEN - BODENBELAG	EN 13823	NON RICHIESTO. NOT REQUIRED. NON DEMANDE NICHT ERFORDERLICH.	A1 class	(NESSUNA REAZIONE) (NO REACTION) (NESSUNA REAZIONE) (NESSUNA REAZIONE)
RESISTENZA AL FUOCO - RIVESTIMENTO FIRE REACTION - WALL RÉSISTANCE AU FEU - REVÊTEMENT BRANDVERHALTEN - WANDBELAG	EN 13823	NON RICHIESTO. NOT REQUIRED. NON DEMANDE NICHT ERFORDERLICH.	A1 class	(NESSUNA REAZIONE) (NO REACTION) (AUCUNE REACTION) (NESSUNA REAZIONE)

RESISTENZA ALLO SCIVOLAMENTO . SLIP RESISTANCE . ANTI-DÉRAPANT . RUTSCHHEMMUNG

DETERMINAZIONE DELLE PROPRIETÀ ANTISCIVOLO TEST OF ANTI-SLIP RESISTANCE DÉTERMINATION DES PROPRIÉTÉS ANTIDÉRAPANTES REIBUNGSKOEZIENT GEBIET	DIN 51130	NON RICHIESTO. NOT REQUIRED. NON DEMANDE NICHT ERFORDERLICH.	R9
DETERMINAZIONE DELLE PROPRIETÀ ANTISCIVOLO TEST OF ANTI-SLIP RESISTANCE DÉTERMINATION DES PROPRIÉTÉS ANTIDÉRAPANTES REIBUNGSKOEZIENT BARFUSSBEREICH	DIN 51097	NON RICHIESTO. NOT REQUIRED. NON DEMANDE NICHT ERFORDERLICH.	B
COEFFICIENTE DI ATTRITO DINAMICO (DCOF) DYNAMIC COEFFICIENT OF FRICTION (DCOF) COEFFICIENT DE FRICTION DYNAMIQUE (DCOF) REIBUNGSKOEZIENT (DCOF)	BOT 3000	0,42	CONFORME. COMPLIANT. CONFORME. ERFÜLLT.
COEFFICIENTE DI ATTRITO DINAMICO (BCRA) DETERMINATION OF SLIP RESISTANCE (BCR TORTUS) COEFFICIENT DE FRICTION DYNAMIQUE (BCRA) REIBUNGSKOEZIENT (BCRA)	DM 236-89	> 0,40	CONFORME. COMPLIANT. CONFORME. ERFÜLLT.

Pesi e imballi

Weights and pack - Poids et emballages - Gewicht und Verpackung

FORMATO SIZE FORMAT FORMAT	SPESSORE THICKNESS ÉPAISSEUR STÄRKE	Pz	Mq	Kg			
120x260	6,5	1	3,12	52,12	Vedi pagina 34 e 35 - See pages 34 and 35 Voir pages 34 et 35 - Siehe Seite 34 und 35		
FORMATO SIZE FORMAT FORMAT	SPESSORE THICKNESS ÉPAISSEUR STÄRKE	Pz x 	Mq x 	Kg x 	 x 	Mq x 	Kg x 
120x120	10,3	1	1,44	35,50	34	48,96	1207,00
60x120	10,3	1	0,72	17,14	42	30,24	720
80x80	10,3	2	1,28	28,16	40	51,20	1126,40
40x80	10,3	3	0,96	22,00	28	26,88	618,00

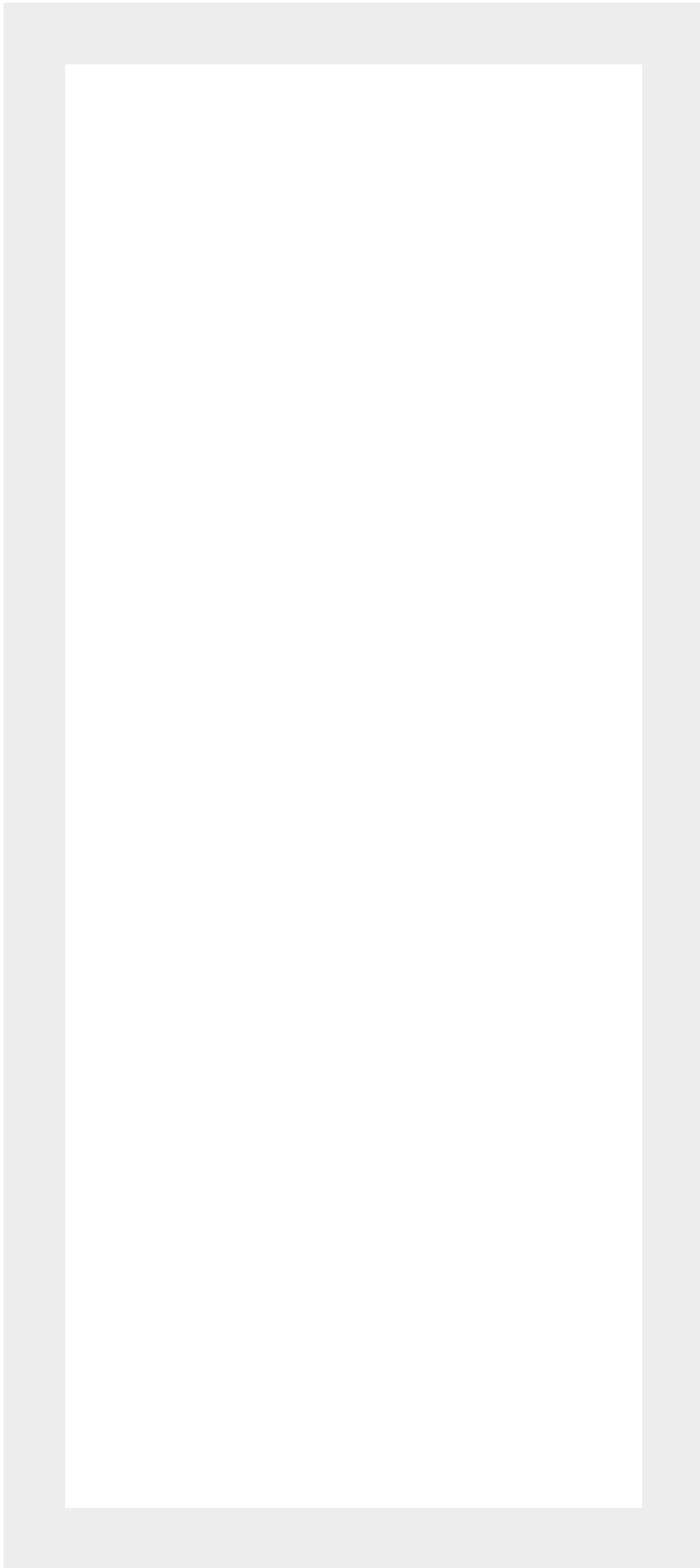

Via Magazzeno, 1944
41056 - Savignano sul Panaro (MO) - ITALY

Tel. +39.059.739.111
Fax +39.059.796.291

e-mail: info@pastorellitiles.com
www.pastorellitiles.com

