

due 2

Gres porcellanato a tutta massa
spessore 20 mm

*Through body porcelain
20 mm thickness*

*Durchgefärbtes Feinsteinzeug
in 20 mm Stärke*

*Grès cérame pleine masse
épaisseur 20 mm*

NATO PER VIVERE ALL'ESTERNO, ANTISCIVOLO, ALTA RESISTENZA ALL'USURA
ESTREMAMENTE RESISTENTE AI CARICHI
LA POSA È SEMPLICE E VELOCE RIMOVIBILE

BORN TO BE OUTDOORS, ANTISLIP, WEAR RESISTANT
HIGHLY RESISTANT TO HEAVY LOADS
QUICK AND EASY INSTALLATION REMOVABLE

FÜR DAS LEBEN IM AUSSENBEREICH GEBOREN, RUTSCHFEST, ABNEHMBAR
HOHE VERSCHLEISSFESTIGKEIT, SEHR BESTÄNDIG GEGEN SCHWERE LASTEN
EINFACHE UND SCHNELLE VERLEGUNG

NÉ POUR VIVRE À L'EXTÉRIEUR, ANTIDÉRAPANT, GRANDE RÉSIDENCE À L'USURE
EXTRÊMEMENT RÉSIDENCE AUX CHARGES ÉLEVÉES
LA POSE EST FACILE ET RAPIDE AMOVIBLE

 DELCONCA

Indice · Index

| | |
|---|-----|
| COS'È due2? WHAT IS due2? WAS IST due2? QU'EST-CE QUE due2? _____ | 2 |
| PERCHÈ SCEGLIERE due2 WHY TO CHOOSE due2 DARUM due2 AUSWAHLEN POURQUOI CHOISIR due2 _____ | 5 |
| SISTEMI DI POSA INSTALLATION SYSTEMS VERLEGUNGSARTEN SYSTEMES DE POSE _____ | 6 |
| POSA CARRABILE CARRIAGEABLE INSTALLATION BEFAHRBARE VERLEGUNG POSE CARROSSABLE _____ | 20 |
| BORDO NATURALE O RETTIFICATO? NATURAL OR RECTIFIED EDGES? PRESSKANTE ODER REKTIFIZIERTE KANTE? BORD NATUREL OU RECTIFIÉ? _____ | 24 |
| LA GAMMA PRODUCT RANGE DIE PRODUKTPALETTE LA GAMME _____ | 26 |
| HFR ² FORUM ² _____ | 28 |
| HBO ² BOUTIQUE ² _____ | 30 |
| HQZ ² QUARTZ ² _____ | 32 |
| HVG ² VIGNONI ² _____ | 33 |
| HDG ² DOGMA ² _____ | 36 |
| HEG ² ENGADINA ² _____ | 38 |
| HAV ² ANVERSA ² _____ | 40 |
| HMN ² MONTEVERDE ² _____ | 44 |
| HDL ² DOLOMITI ² _____ | 46 |
| HED ² EL DORADO ² _____ | 47 |
| HSC ² STONE CAPITAL ² _____ | 48 |
| HCL ² CLIMB ² _____ | 50 |
| HBP ² BLUE PEPPER ² _____ | 52 |
| HBQ ² BLUE QUARRY ² _____ | 53 |
| HUP ² UPGRADE ² _____ | 54 |
| HNT ² NAT ² _____ | 58 |
| HSU ² SOUL ² _____ | 60 |
| HTE ² TREVİ ² _____ | 62 |
| HDV ² DA VINCI ² _____ | 63 |
| HSA ² SALOON ² _____ | 64 |
| HEK ² EPOKAL ² _____ | 66 |
| MONTAGGI MODULARI MODULAR PATTERN INSTALLATIONS MODULARE MONTAGEN POSES MODULAIRES _____ | 68 |
| PEZZI SPECIALI SPECIAL PIECES FORMTEILE PIÈCES SPÉCIALES _____ | 92 |
| PULIZIA E MANUTENZIONE CLEANING AND MAINTENANCE REINIGUNG UND WARTUNG NET TOYAGE ET ENTRETIEN _____ | 99 |
| CARATTERISTICHE TECNICHE TECHNICAL FEATURES TECHNISCHE DATEN CARACTÉRISTIQUES TECHNIQUES _____ | 100 |



Cos'è due2?

What is **due2**? / Was ist **due2**? / Qu'est-ce que **due2**?

due2 è il gres porcellanato di 20 mm di spessore di Ceramica del Conca, la giusta soluzione per pavimentare ogni tipo di superficie esterna. Resistenza all'usura, allo scivolamento, alle azioni meccaniche e agli agenti atmosferici senza compromessi abbinata ad un valore estetico identico ai più avanzati prodotti per interno. Gli articoli della serie **due2** di Ceramica del Conca sono coordinati con articoli di spessore tradizionale per consentire di avere continuità estetica fra l'interno e l'esterno delle abitazioni.

due2 è stato ideato per essere installato a secco in modo semplice e rapido, su erba, sabbia, ghiaia. Ma può essere anche utilizzato per realizzare pavimentazioni sopraelevate perfettamente piane, di pratico utilizzo, di terrazze e lastrici solari consentendo all'acqua piovana di defluire al di sotto della pavimentazione dove viene captata dalla impermeabilizzazione e dove si crea una intercapedine ispezionabile che può essere utilizzata per il passaggio degli impianti e che contribuisce al miglioramento dell'isolamento dell'edificio.

due2, infine, può anche essere incollato con le tecniche tradizionali consentendo di realizzare superfici molto più resistenti alle azioni meccaniche rispetto ad un pavimento con piastrelle da 10 mm. Disponibile con bordi naturali o rettificati, **due2** è prodotto in molteplici formati e stili ed è corredato di numerosi complementi quali i gradoni, i battiscopa, gli elementi ad elle. Sono inoltre possibili lavorazioni personalizzate a richiesta dell'utente o del professionista.

***due2** is the 20 mm thick porcelain stoneware by Del Conca, the right solution for any type of outdoor flooring.*

***due2** is hard-wearing, anti-slip, weather resistant and capable of withstanding heavy loads without compromising aesthetics.*

Del Conca offers corresponding or compatible porcelain tiles made in standard thickness so you can match outdoor with indoor décor.

***due2** was created for quick and easy dry installations on grass, sand and gravel. It can also be used for raised flooring installations that are perfectly level, suitable for terraces and rooftops, allowing rainwater to flow below the floor where it is collected on a waterproof membrane. This installation creates an accessible cavity for utilities and could also improve the thermal insulation of the building.*

***due2** can be installed with adhesive for a floor extremely resistant to heavy loads.*

***due2** comes in a variety of styles and has several special pieces to match, such as steps and pool coping.*

***due2** ist das 20 mm starke Feinsteinzeug von Ceramica del Conca, die richtige Lösung für Fußböden jeder Art im Außenbereich. Eine kompromisslose Verschleiß- und Rutschfestigkeit, Beständigkeit gegen mechanische Einwirkungen und atmosphärische Einflüsse kombiniert mit dem identischen ästhetischen Wert wie die fortschrittlichsten Produkte für den Innenbereich. Für jeden Artikel der Serie **due2** produziert Ceramica del Conca einen entsprechenden Artikel mit traditioneller Stärke, um ästhetische Kontinuität zwischen Innen- und Außenbereiche der Wohnungen haben zu können.*

***due2** ist für einen einfachen und schnellen Trockeneinbau auf Gras, Sand und Kies entwickelt worden. Es kann aber auch für die Realisierung von erhöhten, perfekt waagrecht Fußböden von Terrassen und Flachdächern verwendet werden. Das Regenwasser kann so unter den Boden abfließen, wo es von der Abdichtung abgefangen wird und sich ein inspizierbarer Zwischenraum bildet, der auch für den Durchgang der Leitungen verwendet werden kann und der zur besseren Isolierung des Gebäudes beiträgt.*

***due2** kann schließlich auch mit den traditionellen technischen Methoden angeklebt werden und ermöglicht so die Realisierung von gegen Frost und mechanische Einwirkungen sehr beständigen Oberflächen.*

*Mit natürlichen oder rektifizierten Rändern erhältlich. **due2** wird in verschiedenen Formaten und Stilen hergestellt und ist mit Ergänzungen wie Stufenplatten, Sockelleisten und L-Elemente versehen. Es sind außerdem auf Anfrage des Nutzers oder des Planers individuell gestaltete Bearbeitungen möglich.*

***due2** est le grès cérame d'une épaisseur de 20 mm de Ceramica del Conca, la solution idéale pour revêtir tout type de surface externe. Une résistance à l'usure, au glissement, aux actions mécaniques et aux agents atmosphériques sans compromis associée à une valeur esthétique identique aux produits pour intérieur les plus avancés. Pour tout article de la série **due2**, Ceramica del Conca produit un article à l'épaisseur traditionnelle équivalent afin de permettre une continuité esthétique entre les zones internes et externes des habitations.*

***due2** a été conçu pour être installé à sec de manière simple et rapide, sur herbe, sable et gravier. Mais il peut également être utilisé pour réaliser des sols surélevés parfaitement plats pour une utilisation plus pratique, des terrasses et planchers tout en permettant à l'eau de pluie de s'écouler sous le sol où elle est récupérée grâce à l'imperméabilisation et où se crée une cavité pouvant être inspectée et utilisée pour le passage des installations, tout en contribuant à l'amélioration de l'isolation de l'édifice.*

*Enfin, **due2** peut être collé selon les techniques traditionnelles permettant ainsi de réaliser des surfaces très résistantes au gel et aux actions mécaniques.*

*Disponible avec des bords naturels ou rectifiés, **due2** est un produit disponible en de nombreux formats et styles, et associé à de multiples compléments tels que les nez de marche, les plinthes et les éléments « L ». Sont également disponibles des traitements personnalisés sur demande de l'utilisateur ou du professionnel.*

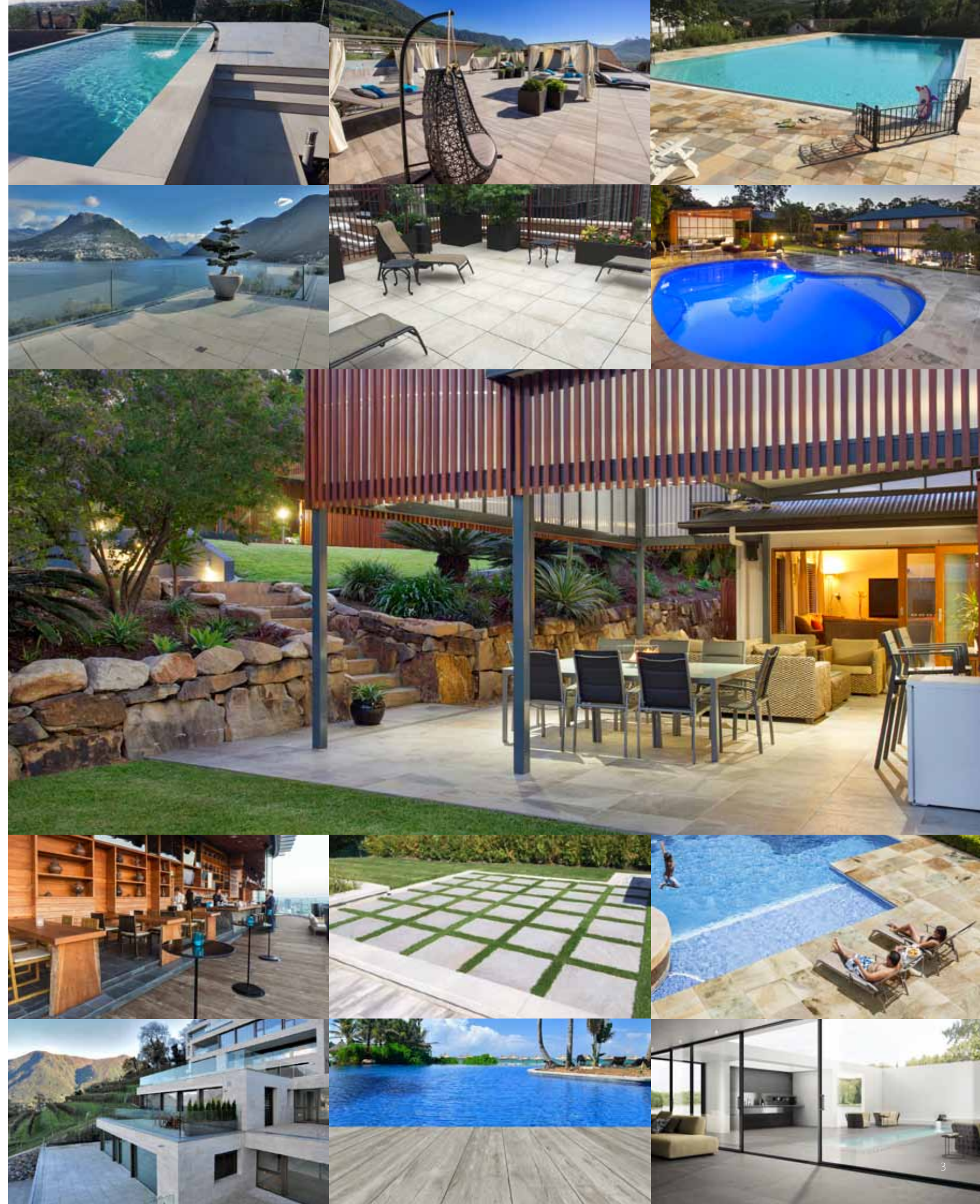

due 2

Perchè scegliere due2

Why to choose **due2**
Darum **due2** auswählen
Pourquoi choisir **due2**

Per le serie che compongono la linea **due2** è spesso disponibile anche la versione coordinata da interno.

A matching version for interiors is often available on series included in the **due2** line.

Zusätzlich zu den Terrassen Platten **due2** sind häufig die gleichfarbige Platten für den Innenbereich lieferbar.

Pour les séries qui composent la gamme **due2** il est souvent disponible aussi la version coordonnée pour l'intérieur.



INGELIVO
FROST RESISTANT
FROSTBESTÄNDIG
INGÉLIF



COLORI RESISTENTI NEL TEMPO
COLORS DO NOT FADE OVER TIME
DIE FARBEN NICHT VERBLASSEN MIT DER ZEIT
COULEURS NE SE DÉCOLORENT PAS AU FIL DU TEMPS



RESISTENTE AGLI SBALZI TERMICI
RESISTANT TO SUDDEN
TEMPERATURE CHANGES
BESTÄNDIG GEGENÜBER
TEMPERATURSCHWANKUNGEN
RÉSISTANT AUX VARIATIONS
DE TEMPÉRATURE



RESISTENTE A ACIDI, PRODOTTI CHIMICI, SALE...
RESISTANT TO ACID, CHEMICALS, SALT, ETC.
BESTÄNDIG GEGENÜBER SÄURE,
CHEMIKALIEN, SALZ...
RÉSISTANT AUX ACIDES, PRODUITS
CHIMIQUES, AU SEL...



MUFFE E MUSCHI NON LO DANNEGGIANO
RESISTANT TO DAMAGE FROM MOULD
AND MOSS
SCHIMMEL UND MOOSE BESCHÄDIGEN
ES NICHT
LES MOISSURES ET LES MOUSSES
NE L'ENDOMMAGENT PAS



FACILE DA PULIRE
EASY TO CLEAN
REINIGUNGSFREUNDLICH
FACILE À NETTOYER



POSA FACILE E VELOCE
QUICK AND EASY TO INSTALL
EINFACHE UND SCHNELLE VERLEGUNG
POSE FACILE ET RAPIDE



FACILMENT REMOVIBILE
EASY TO REMOVE
LEICHT ABNEHMBAR
FACILEMENT AMOVIBLE



RIUTILIZZABILE
REUSABLE
WIEDERVERWENDBAR
RÉUTILISABLE



ISPEZIONABILE
READILY SERVICEABLE
INSPIZIERBAR
PEUT-ÊTRE INSPECTÉ



PERMETTE ANCHE POSA CON COLLA
INSTALLATION WITH ADHESIVE POSSIBLE
ERMÖGLICHT AUCH DIE VERLEGUNG MIT KLEBER
PERMET ÉGALEMENT UNE POSE AVEC COLLE

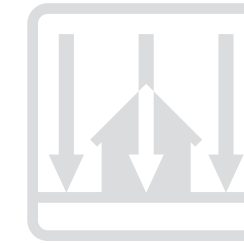

COORDINATO CON PAVIMENTO PER INTERNO
MATCHES INTERIOR FLOORING
KOORDINIERT MIT BODEN FÜR INNENBEREICHE
COORDONNÉ AU SOL POUR INTÉRIEUR



ANTISCIVOLO
ANTISLIP
RUTSCHEFEST
ANTIDÉRAPANT

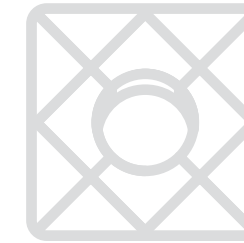

PEZZI SPECIALI COORDINATI
SPECIAL MATCHING PIECES
KOORDINIERTE FORMTEILE
PIÈCES SPÉCIALES COORDONNÉES

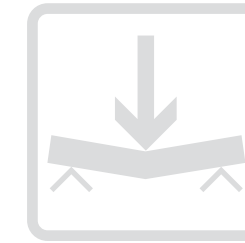

ALTAMENTE RESISTENTE AI CARICHI
HIGHLY RESISTANT TO LOADS
SEHR BESTÄNDIG GEGEN BELASTUNGEN
HAUTEMENT RÉSISTANT AUX CHARGES



PERMETTE IL DEFLUSSO DELL'ACQUA
ALLOWS WATER DRAINAGE
ERLAUBT DEN WASSERABFLUSS
PERMET À L'EAU DE S'ÉCOULER



IDEALE PER POSA SOPRAELEVATA
SUITABLE FOR RAISED INSTALLATIONS
IDEAL FÜR DIE VERLEGUNGEN ALS DOPPELBODEN
IDÉAL POUR UNE POSE SURÉLEVÉE



LUNGHISSIMA DURATA NEL TEMPO
EXTREMELY LONG-LASTING
SEHR LANGE HALTBARKEIT
TRÈS LONGUE DURÉE DE VIE



AMPIA GAMMA DI FINITURE
WIDE RANGE OF FINISHES
BREIT GEFÄCHERTES ANGEBOT
AN OBERFLÄCHENBEARBEITUNGEN
VASTE GAMME DE FINITIONS



INASSORBENTE
IMPERVIOUS
UN DURCHLÄSSIG
NON ABSORBANT

Sistemi di posa

Installation systems / Verlegungsarten / Systèmes de pose

Posa su massetto
 Altissima resistenza ai carichi
 Installation on screed
 Highly resistant to loads
 Verlegung auf Estrich
 Hohe Beständigkeit gegen Belastungen
 Pose sur chape
 Très haute résistance aux charges

Posa su erba
 Installation on grass
 Verlegung auf Gras
 Pose sur herbe

Posa su sabbia
 Installation on sand
 Verlegung auf Sand
 Pose sur sable

Posa su ghiaia
 Installation on gravel
 Verlegung auf Kies
 Pose sur gravier

Posa sopraelevata
 Raised installation
 Verlegung als Doppelboden
 Pose surélevée

La posa in appoggio

Lay-on installation / Die Verlegung durch Auflegen / La pose flottante

Posa su erba

Installation on grass / Verlegung auf Gras / Pose sur herbe

(consigliata versione con bordi naturali)

(natural edges version recommended / es wird die Version mit natürlichen Rändern empfohlen / conseillée en version avec bords naturels)



La posa su erba può essere eseguita in due modi:

- A) Diretta:** appoggiare la piastrella sul manto erboso [1] lasciando fughe di 4/5 cm dove possa crescere l'erba. Il risultato sarà di buona durata ma soggetto ai movimenti del terreno.
- B) Con sottofondo:**
- rimuovere l'erba [1] sotto alla sagoma di **due2**
 - scavare 5 cm in climi caldi e asciutti o più in profondità in climi freddi e/o umidi.
 - compattare il terreno sul fondo.
 - riempire lo scavo di ghiaia [2] (granulometria 4-8 mm) o sabbia e compattarla.
 - posare **due2** a secco.

Installation on grass can be performed in two ways:

- A) Direct:** set the tile on grass [1] leaving 4-5 cm wide joints to allow the grass to grow. Results will be long lasting but stability will be subject to soil movements.
- B) On gravel base:**
- remove the grass [1] from the area underneath **due2**
 - dig 5 cm deep in warm and dry climate, or deeper in cold or wet climates.
 - compact the soil.
 - fill the excavated area with gravel (size 4-8 mm) or sand [2] and compact it.
 - dry set **due2**

Le stratigrafie prese in considerazione sono unicamente indicative delle varie tipologie di applicazione: si raccomanda di fare riferimento alle normative specifiche di ogni singolo paese al fine di una realizzazione a regola d'arte.

The stratigraphy considered is solely indicative of the various types of application: we recommend referring to local regulations in order to achieve a correct installation.

Die Verlegung auf Gras kann auf zwei verschiedenen Arten erfolgen:

- A) Direkte Verlegung:** Platte auf den Rasen [1] mit 4/5 cm breiten Fugen auflegen damit das Gras wachsen kann. Es wird ein gutes und dauerhaftes Ergebnis geben, jedoch von möglichen Erdbewegungen abhängig.
- B) Mit vorbereitetem Untergrund:**
- Gras unter dem Plattenprofil **due2** entfernen [1].
 - In trockenen und heißen Gebieten, eine Schicht bis 5 cm ausgraben, etwas mehr in kalten und feuchten Gebieten.
 - Grund verdichten.
 - Das Graben mit Kies [2] (4-8 mm Durchmesser) oder Sand füllen und verdichten.
 - Platten **due2** trockenverlegen.

La pose sur herbe peut être effectuée de deux manières:

- A) Directe:** poser la dalle sur la pelouse [1] en laissant des joints de 4/5 cm pour permettre à l'herbe de pousser. Le résultat sera de bonne durée mais dépendra des mouvements du terrain.
- B) Avec sous-couche:**
- enlever l'herbe [1] à l'endroit où il sera posé **due2**.
 - creuser le terrain pour 5 cm dans des régions avec un climat chaud et sec ou plus en profondeur dans des régions froides et humides.
 - compacter le terrain.
 - remplir le trou avec du gravier [2] (granulométrie de 4-8 mm) ou de sable et compacter.
 - poser **due2** à sec

Die vorgeschlagene Stratigraphie dient nur als Richtlinie für die verschiedenen Arten von Anwendung. Es empfiehlt sich, auf die landesspezifischen Vorschriften Bezug zu nehmen, um einen fachmännischen Fußboden zu schaffen.

Les stratigraphies prises en compte indiquent uniquement les différentes typologies d'application: il est conseillé de se référer aux normes spécifiques de chaque pays afin d'effectuer une réalisation dans les règles de l'art.

due 2

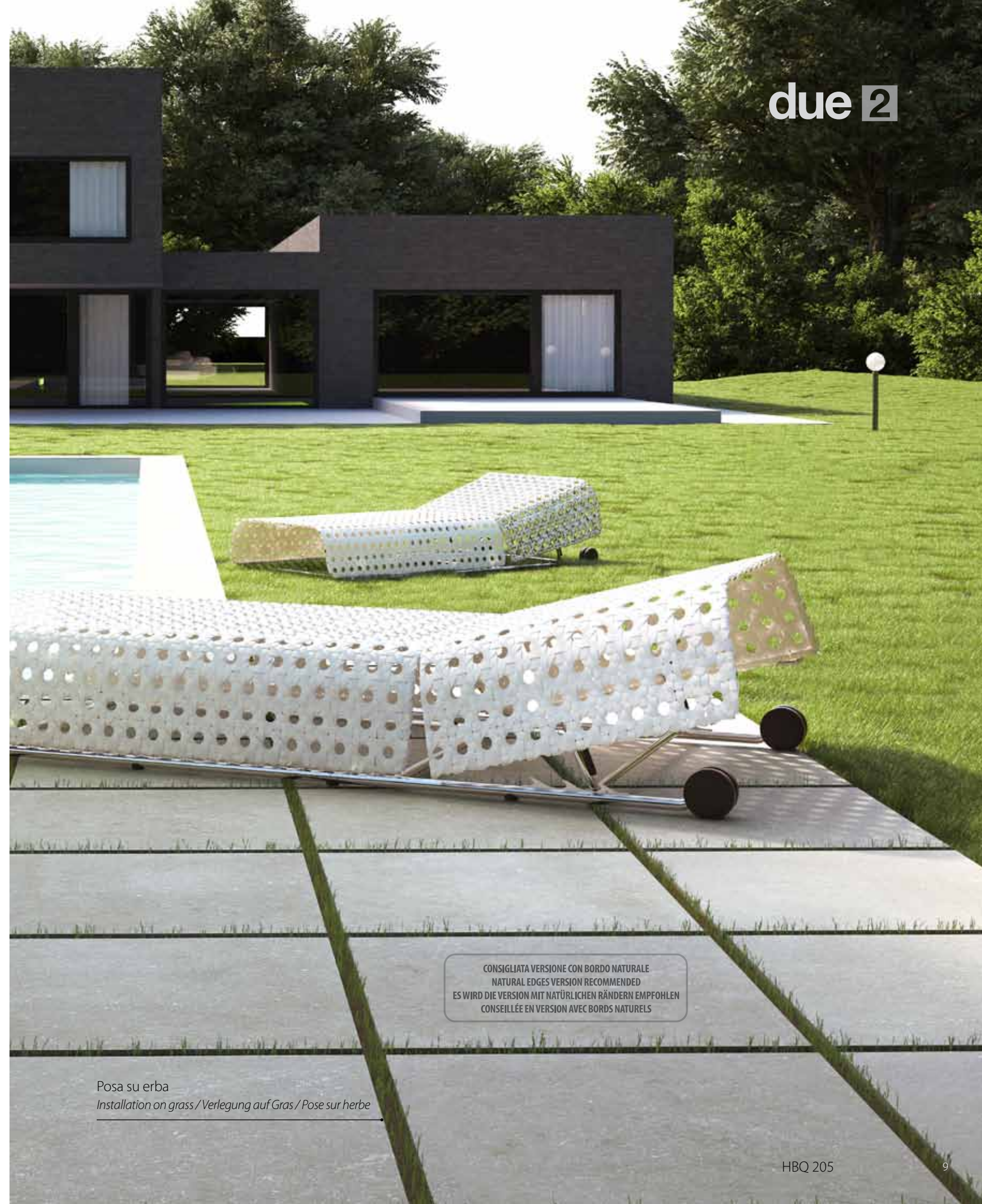

CONSIGLIATA VERSIONE CON BORDO NATURALE
NATURAL EDGES VERSION RECOMMENDED
ES WIRD DIE VERSION MIT NATÜRLICHEN RÄNDERN EMPFOHLEN
CONSEILLÉE EN VERSION AVEC BORDS NATURELS

Posa su erba
Installation on grass / Verlegung auf Gras / Pose sur herbe

Posa su ghiaia

Installation on gravel / Verlegung auf Kies / Pose sur gravier

(consigliata versione con bordi naturali)

(natural edges version recommended / es wird die Version mit natürlichen Rändern empfohlen / conseillée en version avec bords naturels)

due2

[3] Ghiaia fine (Ø 2-5 mm)

[2] Pietrisco o ghiaia (Ø 4-8 mm)

[1] Terreno



Indicata per superfici ampie, per pose con fughe di ampiezza ridotta o senza erba.

- Escavare il terreno [1] per una profondità di almeno 10 cm in climi asciutti e con terreno drenante, o superiore in climi freddi o piovosi.
- Compattare il fondo dello scavo e assicurarsi che sia in leggera pendenza ($\geq 2\%$) per evitare il ristagno di acqua.
- Opzionale: posizionare uno strato di tessuto-non-tessuto.
- Posizionare e compattare uno strato di pietrisco o ghiaia [2] (granulometria 4-8 mm)
- Posizionare e compattare uno strato di ghiaia fine [3] (granulometria 2-5 mm) per rendere più facile il livellamento della superficie.
- Controllare la planarità della superficie con una staggia. Si consiglia di lasciare una pendenza $\geq 1\%$ per assicurare il deflusso dell'acqua dal pavimento.
- Installare **due2** a secco lasciando fughe di almeno 2 mm. In fase di posa possono essere usati distanziatori ("crocette") usati per la posa delle piastrelle. Controllare la planarità del pavimento con la staggia e usare un martello di gomma per correggere piccole differenze di livello.
- Riempire le fughe con sabbia molto fine (granulometria 0-3 mm) oppure con sabbia fine additivata di polimeri.

Recommended for larger areas, for installation with thin joints or joints without grass.

- Excavate the soil [1] at least 10 cm deep in warm and dry climate, or deeper in cold or wet climates.
- Compact the soil on the bottom and ensure it is sloped ($\geq 2\%$) to avoid stagnation of water.
- Optional - place a layer of geotextile.
- Place and compact a layer of crushed stone or gravel (size 4-8 mm) [2]
- Place and compact a layer of fine gravel or sand (size 2-5 mm) [3] to ease the leveling of the surface.
- Ensure the surface is level using a straightedge. A slight slope ($\geq 1\%$) is recommended to ensure proper drainage of the floor.
- Dry set **due2** leaving joints at least 2 mm wide. Tile spacers can be used to facilitate installation. Ensure the floor is level with a straightedge and use a rubber hammer to correct small differences in height.
- Fill the joints with very fine sand (size 0-3 mm) or polymeric sand.

Für grösseren Flächen und für Verlegung mit dünnen Fugen ohne Gras empfohlen.

- Erdboden [1] bis mindestens 10 cm Tiefe in trockenen und heissen Gebieten, oder noch tiefer in kalten und feuchten Gebieten ausgraben.
- Untergrund verdichten und mit einem Gefälle ($\geq 2\%$) versehen, damit es sich keine Wasserstauung bilden kann.
- Freigestellt: Kunststoffmatte verlegen.
- Darauf Kiesschicht (4-8 mm Durchmesser) [2] füllen und verdichten.
- Danach eine Schicht Feinkies [3] (2-5 mm Durchmesser) auftragen, um das Niveau besser ausgleichen zu können.
- Die Fläche-Ebenheit prüfen und ein Gefälle von $\geq 1\%$ geben, um den Wasserablauf zu gewährleisten.
- **due2** Platten mit mindestens 2 mm Fugen trockenverlegen. Während der Verlegung dürfen auch Kreuzplättchen wie bei Fliesenverlegung verwendet werden. Ebenheit ständig prüfen und gegebenenfalls Niveau Unregelmässigkeiten mit einem Gummihammer korrigieren.
- Fugen mit Feinsand ausfüllen (0-3 mm Durchmesser) oder mit harzgebundenen Drainagesand.

Indiquée pour des vastes surfaces, pour une pose avec des joints très réduits ou sans herbe.

- Creuser le terrain [1] pour au moins 10 cm dans des régions avec un climat sec et avec terrain drainant, ou plus en profondeur dans des régions avec un climat froid ou pluvieux.
- Compacter le fond du creusement en s'assurant de laisser une légère pente ($\geq 2\%$) pour éviter la stagnation de l'eau.
- Facultatif: positionner une couche de tissu non tissé. Placer et compacter une couche de cailloutis ou gravier [2] (granulométrie 4-8 mm)
- Placer et compacter une couche de cailloutis fin [3] (granulométrie 2-5 mm) pour faciliter le nivelage de la surface.
- Contrôler la planéité de la surface au moyen d'une règle. Il est conseillé de laisser une pente $\geq 1\%$ pour assurer l'écoulement de l'eau.
- Poser **due2** à sec en laissant des joints de au moins 2 mm. Pendant la pose on peut utiliser des écarteurs ("croisillons") utilisés pour la pose des carreaux. Contrôler la planéité du sol au moyen d'une règle et utiliser un marteau en caoutchouc pour corriger les petites différences de niveau.
- Remplir les joints avec du sable très fin (granulométrie 0-3 mm) ou avec du sable polymère.

Le stratigrafie prese in considerazione sono unicamente indicative delle varie tipologie di applicazione: si raccomanda di fare riferimento alle normative specifiche di ogni singolo paese al fine di una realizzazione a regola d'arte.

The stratigraphy considered is solely indicative of the various types of application: we recommend referring to local regulations in order to achieve a correct installation.

Die vorgeschlagene Stratigraphie dient nur als Richtlinie für die verschiedenen Arten von Anwendung. Es empfiehlt sich, auf die landesspezifischen Vorschriften Bezug zu nehmen, um einen fachmännischen Fußboden zu schaffen.

Les stratigraphies prises en compte indiquent uniquement les différentes typologies d'application: il est conseillé de se référer aux normes spécifiques de chaque pays afin d'effectuer une réalisation dans les règles de l'art.

due2

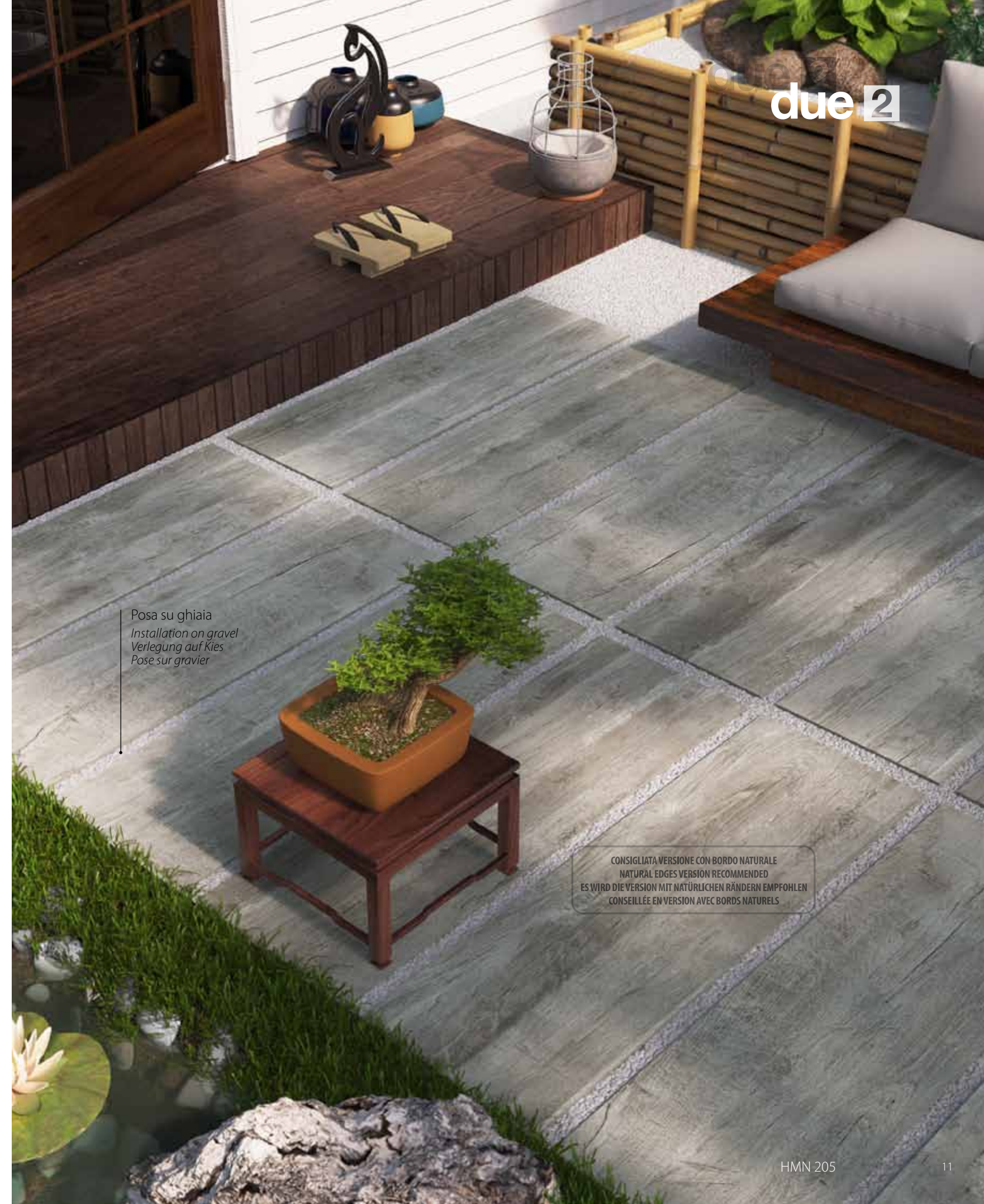

Posa su ghiaia
Installation on gravel
Verlegung auf Kies
Pose sur gravier

CONSIGLIATA VERSIONE CON BORDO NATURALE
NATURAL EDGES VERSION RECOMMENDED
ES WIRD DIE VERSION MIT NATÜRLICHEN RÄNDERN EMPFOHLEN
CONSEILLÉE EN VERSION AVEC BORDS NATURELS

Posa su sabbia

Installation on sand / Verlegung auf Sand / Pose sur sable

(consigliata versione con bordi naturali)

(natural edges version recommended / es wird die Version mit natürlichen Rändern empfohlen / conseillée en version avec bords naturels)

due2



[1] Sabbia

La posa su sabbia può essere eseguita direttamente:

- livellare e compattare la sabbia [1]
- installare **due2** a secco

Installation on sand can be performed directly:

- level and compact the sand [1]
- dry set **due2**

Verlegung auf Sandbett darf direkt ausgeführt werden:

- Sandniveau regulieren und verdichten [1]
- **due2** Platten trockenverlegen

La pose sur sable peut être effectuée directement:

- mettre à niveau et compacter le sable [1]
- poser **due2** à sec

Le stratigrafie prese in considerazione sono unicamente indicative delle varie tipologie di applicazione: si raccomanda di fare riferimento alle normative specifiche di ogni singolo paese al fine di una realizzazione a regola d'arte.

The stratigraphy considered is solely indicative of the various types of application: we recommend referring to local regulations in order to achieve a correct installation.

Die vorgeschlagene Stratigraphie dient nur als Richtlinie für die verschiedenen Arten von Anwendung. Es empfiehlt sich, auf die landesspezifischen Vorschriften Bezug zu nehmen, um einen fachmännischen Fußboden zu schaffen.

Les stratigraphies prises en compte indiquent uniquement les différentes typologies d'application: il est conseillé de se référer aux normes spécifiques de chaque pays afin d'effectuer une réalisation dans les règles de l'art.

Posa su massetto

Installation on concrete slab / Verlegung auf Estrich / Pose sur chape

(versione con bordi naturali oppure con bordi rettificati per fughe più sottili)

(natural edges version or rectified edges for thinner joints / es kann sowohl die Version mit natürlichen Rändern als auch die mit rektifizierten Rändern verwendet werden, um schmalere Fugen zu erhalten / version avec bords naturels ou avec bords rectifiés pour des joints plus fins)

due2

[4] Colla cementizia elastica

[3] Massetto

[2] Pietrisco o ghiaia (Ø 4-8 mm)

[1] Terreno



Indicata per applicazioni carrabili o sottoposte a sollecitazioni eccezionali. Incollare **due2** su massetto cementizio. Lasciare fuga da 2 mm almeno e rispettare i giunti di dilatazione.

Per una posa su massetto su terreno:

- realizzare lo scavo e compattare il fondo [1]
- posizionare uno strato di pietrisco e stabilizzato [2]
- realizzare il massetto [3] con eventuale rete elettrosaldata
- procedere alla posa di **due2** con colla cementizia elastica [4] per esterni.

Installation with thin set on concrete slab recommended for areas open to vehicular traffic or subject to very high stress: leave joints of at least 2 mm and respect expansion joints.

To install on concrete slab on ground:

- complete the digging and compact the ground [1]
- place a layer of crushed stone and gravel [2]
- place the slab [3] including optional steel mesh
- Install **due2** exterior-rated elastic adhesive [4]

Für befahrbaren oder außergewöhnlichen Belastungen ausgesetzte Anwendungen die Verlegung von **due2** vornehmen, indem man es auf Zementestrich anklebt. Fugen von mindestens 2 mm lassen und die Dehnungsfugen einhalten.

Realisierung eines Estrichs auf Erdreich:

- die Ausgrabung vornehmen und den Grund [1] verdichten
- eine Schicht Schotter und Stabilisator [2] positionieren
- den Estrich [3] mit einem eventuellen elektrogeschweißten Netz realisieren
- die Verlegung von **due2** mit (elastischem) Zementkleber [4] für den Außenbereich vornehmen

Pour des applications pour véhicules ou soumises à des sollicitations exceptionnelles, poser **due2** en le collant sur une chape de ciment. Laisser des joints de 2 mm au moins et respecter les joints de dilatation.

Pour réaliser une chape sur terrain :

- creuser une fosse et compacter le fond [1]
- poser une couche de cailloutis stabilisée [2]
- réaliser la chape [3] avec un éventuel réseau électro-soudé
- poser **due2** au moyen d'une colle de ciment (élastique) [4] pour extérieurs

Posa su sabbia

Installation on sand
Verlegung auf Sand
Pose sur sable



CONSIGLIATA VERSIONE CON BORDO NATURALE
NATURAL EDGES VERSION RECOMMENDED
ES WIRD DIE VERSION MIT NATÜRLICHEN RÄNDERN EMPFOHLEN
CONSEILLÉE EN VERSION AVEC BORDS NATURELS



HSU 205

Membrana impermeabilizzante
Waterproofing membrane
Abdichtungsmembran
Membrane imperméabilisante

Supporti
Pedestals
Stelzlager
Supports

Massetto di pendenza
Sloping screed
Schiefe Ebene
Plan incliné

La posa sopraelevata

Raised installation / Die Verlegung als Doppelboden / La pose surélevée

Posa sopraelevata

Su terrazze o solai praticabili è possibile realizzare un pavimento sopraelevato piano, che permette comunque l'evacuazione dell'acqua piovana.

Dopo la realizzazione del solaio e delle relative pendenze, installare la guaina impermeabilizzante.

Posizionare i supporti in base al formato scelto utilizzando se necessario i correttori di pendenza.

Durante la posa regolare ciascun supporto per ottenere un pavimento planare.

Come si taglia

Per tagliare due2 è necessario utilizzare dischi appositi per Gres Porcellanato, disponibili sia per taglio a secco che ad acqua.

Raised installation

On terraces or accessible attics, it is possible to build a raised level flooring that still allows rainwater drainage.

After the slab and its sloping screed are complete, install the waterproofing membrane.

Position the pedestals according to the chosen sizes, if necessary use the slope correctors.

During the installation, adjust each pedestal to achieve a flat floor.

How to cut it

To cut due2, it is necessary to use discs designed for Porcelain Stoneware, available for both dry and wet cutting.

Verlegung als Doppelboden

Auf Terrassen oder begehbaren Dachböden kann man einen flachen Doppelboden realisieren, der den Abfluss des Regenwassers erlaubt. Nach der Realisierung des Dachbodens und der entsprechenden Neigungen die Abdichtungsbahn einbauen.

Die Unterlagen je nach dem gewählten Format positionieren, wenn nötig mit der Verwendung des Neigungsausgleichers. Während der Verlegung jede Unterlage regulieren, um einen flachen Boden zu erhalten.

Wie schneidet man es?

Um due2 zu schneiden erfordert man eigens für Feinsteinzeug vorgesehene Scheiben, sowohl für Trockenschnitt als auch für Nass-Schnitt.

Pose surélevée

Sur des terrasses ou planchers praticables, il est possible de réaliser un sol surélevé plat qui permet dans tous les cas l'écoulement de l'eau de pluie. Après la réalisation du plancher et des pentes correspondantes, installer la gaine imperméabilisante.

Positionner les supports selon le format choisi en utilisant au besoin des correcteurs de pente.

Au cours de la pose, régler les supports pour obtenir un sol plat.

Comment le couper?

Pour couper due2, il est nécessaire d'utiliser des disques adaptés au Grès Cérame, disponibles pour la coupe à sec et à eau.

Le stratigrafie prese in considerazione sono unicamente indicative alle varie tipologie di applicazione: si raccomanda di fare riferimento alle normative specifiche di ogni singolo paese al fine di una realizzazione a regola d'arte.

The stratigraphy considered is solely indicative of the various types of application: we recommend referring to the local regulations in order to achieve a correct installation.

Die vorgeschlagene Stratigraphie dient nur als Richtlinie für die verschiedenen Arten von Anwendung. Es empfiehlt sich, auf die landesspezifischen Vorschriften Bezug zu nehmen, um einen fachmännischen Fußboden zu schaffen.

Les stratigraphies prises en compte indiquent uniquement les différentes typologies d'application: il est conseillé de se référer aux normes spécifiques de chaque pays afin d'effectuer une réalisation dans les règles de l'art.





Alette preincise per una facile asportazione.
Pre-cut tabs for easy remove.
Abstandhalter mit Sollbruchstellen,
leicht entfernbar.
Des ailettes prédecoupées facilement cassables.



Chiave di regolazione rinforzata.
Reinforced adjustment key.
Verstärkter Einstellschlüssel.
Clef de réglage renforcée.

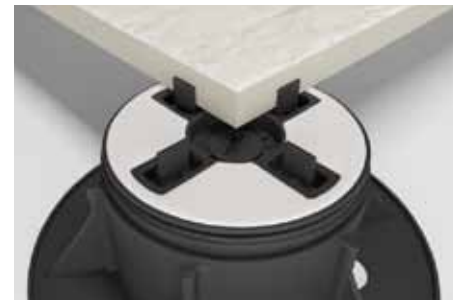

Testa in bi-materiale PP+gomma anti-rumore e anti-scivolamento.
Bi-material head PP + rubber anti-noise and anti-slip.
PP + Gummi-Kopf schützt vor Lärm und Rutschen.
Tête en bi-matériau PP + caoutchouc antibruit et antidérapant.

Supporti regolabili con testa fissa

Adjustable pedestals with fixed head • Verstellbare Stütze mit festen Kopf • Plot réglable à tête fixe

Supporti di altezza superiore sono disponibili a richiesta

Taller pedestals are available on request.
Höher verstellbare Stelzlager sind auf Anfrage vorhanden.
Supports de hauteur majeure disponibles sur demande.

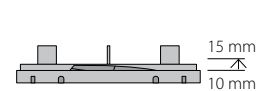

Supporto a testa fissa
10-15 mm 2/5 - 3/5 in



± 5 mm

Prolunga per supporto
5 mm 1/5 in



Prolunga per supporto 10-15 mm

Extension for 10-15mm pedestal
Rallonge pour support 10-15 mm
Höhenverstellstück für Stelzlager 10-15 mm

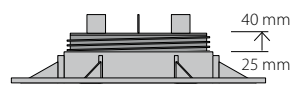

Supporto a testa fissa
25-40 mm 1 - 1 3/5 in

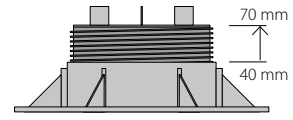

Supporto a testa fissa
40-70 mm 1 3/5 - 2 3/4 in

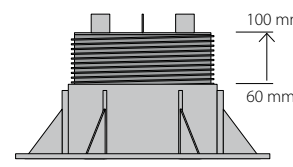

Supporto a testa fissa
60-100 mm 2 1/3 - 4 in



PORTATA DEI SUPPORTI
PEDESTALS LOAD BEARING DETAILS
STELZLAGER-TRAGFAEHIGKEIT
PORTEE DES SUPPORTS

Carico operativo = 1000 kg cadauno. Carico di rottura > 2000 kg cadauno.
Operating load = 1000 kg each (2204 lbs). Breaking load > 2000 kg each (4409 lbs)
Nutzlast: 1000 Kg./Stk. Bruchlast: 2000 Kg./Stk
Charge opérationnelle = 1000 kg chacun. Charge de rupture > 2000 kg chacun

Correttore di pendenza

Slope regulator • Neigungsverstellager • Correcteur de pente



1% 200

Per pendenze superiori al 1% è possibile sovrapporre più correttori di pendenza.

For slopes over 1%, two or more slope regulators can be piled up on each other.

Bei Gefällen ueber 1% darf man mehreren Neigungsregler aufeinander verwenden.

Pour des pentes supérieures à 1% on peut superposer plusieurs correcteurs de pente.

Posa sopraelevata con correttori di pendenza

Raised laying with Slope regulators
Verlegung auf Stelzlager mit Neigungsreglern
Pose surélevée avec correcteurs de pente

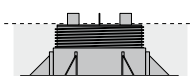

Superfici planari
Plane surfaces
Gleichebenen Flaechen
Surfaces planes



Superfici inclinate
Inclined surfaces
Flächen mit Neigungswinkel
Surfaces inclinées



Per un corretto deflusso dell'acqua si consiglia la posa con una pendenza minima di 1%

Si ricorda comunque che, grazie ai vantaggi propri del gres porcellanato, due2 ha un assorbimento d'acqua praticamente nullo, caratteristica che lo rende ingelivo. Ciò può comportare ristagni di acqua localizzati principalmente sui bordi delle lastre, evento non imputabile ad errori di posa.

For a proper water outflow we suggest to lay with 1% minimum slope

Please remember in any case that, thanks to the distinctive advantages of porcelain stoneware, due2 absorbs almost no water, which makes it highly frost-proof. This may lead to localised water pooling, mainly on the edges of the tiles, independently of the quality of the laying.

Um den normalen Wasserabfluss zu gewährleisten, wird eine Verlegung mit mindestens 1% Gefälle empfohlen.

Es wird daran erinnert, dass due2 Serien, aufgrund der technischen Eigenschaften des Feinsteinzeugs, kein Wasser absorbieren weshalb sie auch als frostsicher bezeichnet werden. Diese Eigenschaft kann zu geringen Wasseransammlungen an den Rändern der Platten führen, unabhängig davon, ob das Material fachmännisch verlegt wurde.

Pour un écoulement correct de l'eau il est recommandé de poser avec une pente minimale de 1%

Compte tenu des atouts propres au grès cérame et par lesquels il se distingue, due2 est un matériau à l'absorption quasi nulle, ce qui en fait un produit ingélif. Cela peut comporter des stagnations d'eau principalement sur les bords des plaques, indépendamment d'une pose du matériau exécutée dans les règles de l'art.



L'auto-livellamento permette di compensare automaticamente pendenze fino al 5%

The self-levelling stand allows it to automatically compensate any gradient up to 5%

Die Selbstnivellierung erlaubt einen automatischen Ausgleich von Gefällen bis zu 5%.

L'auto-nivellement permet de compenser automatiquement des pentes jusqu'à 5%.

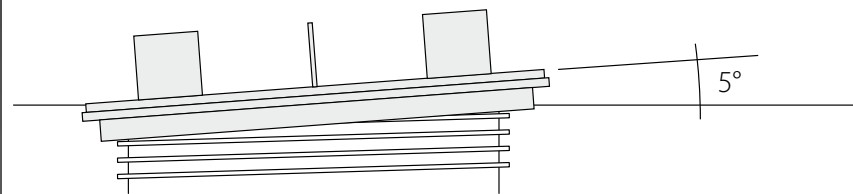

Supporti regolabili con testa autolivellante

Adjustable pedestals with self-levelling head • Verstellbare Stütze mit selbstnivellierendem Kopf • Plot réglable à tête auto-nivelante

Supporti di altezza superiore sono disponibili a richiesta

Taller pedestals are available on request.
Höher verstellbare Stelzlager sind auf Anfrage vorhanden.
Supports de hauteur majeure disponibles sur demande.

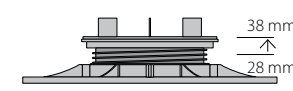

Supporto a testa autolivellante
28-38 mm 1 1/10 - 1 1/2 in

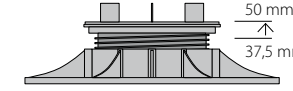

Supporto a testa autolivellante
37,5-50 mm 1 1/2 - 2 in

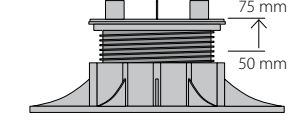

Supporto a testa autolivellante
50-75 mm 2 - 3 in

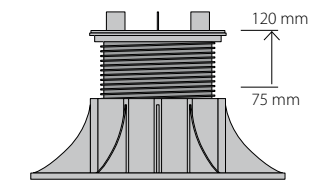

Supporto a testa autolivellante
75-120 mm 3 - 4 3/4 in



PORTATA DEI SUPPORTI
PEDESTALS LOAD BEARING DETAILS
STELZLAGER-TRAGFAEHIGKEIT
PORTEE DES SUPPORTS

Carico operativo = 500 kg cadauno. Carico di rottura > 1000 kg cadauno.
Operating load = 500 kg each (1102 lbs). Breaking load > 1000 kg each (2204 lbs)
Nutzlast: 500 Kg./Stk. Bruchlast: 1000 Kg./Stk
Charge opérationnelle = 500 kg chacun. Charge de rupture > 1000 kg chacun

PRIMO E UNICO SUPPORTO AL MONDO DOTATO DI TESTA CON FINITURA IN GOMMA IN GRADO DI ABBATTERE IL LIVELLO SONORO FINO A 25 dB

The world's first and only pedestal to be equipped with a head finished in rubber that's capable of reducing noise levels to as little as 25 dB

Premier et seul plot au monde doté d'une tête avec finition en caoutchouc permettant de réduire le niveau sonore jusqu'à 25 db

Erstes und einziges Stelzlager versehen mit gummibeschichtetem KOPF zur LÄRMVERMINDERUNG um bis zu 25 dB.

Per una corretta posa per uso pedonale non carrabile, si consiglia di disporre i supporti come segue:

For a correct installation, for non-vehicular usage, place the pedestals as follows:

Für eine korrekte Verlegung wird empfohlen, die Unterlagen aufzustellen wie folgt:

Pour une pose correcte, il est conseillé de positionner les supports comme suit:

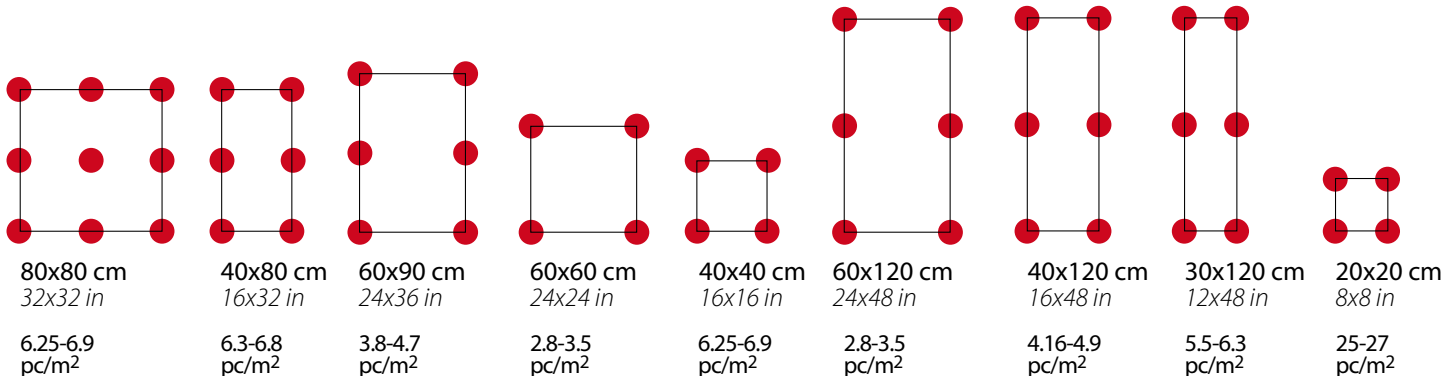

Numero di supporti necessari a m²

Required pedestals per m² - Stelzlageranzahl pro Quadratmeter - Nombre de plots nécessaires au m²

Il numero di supporti necessari varia in funzione del formato e della forma dell'ambiente in cui viene posato. - The number of necessary pedestals varies in depending on the tile format. Die Anzahl der notwendigen Unterlagen hängt vom Fliesenformat ab. - Nombre de supports nécessaires en fonction du format de la dalle.

Scarica i disegni tecnici in DWG/PDF da www.delconca.com
Download the technical instruction in DWG/PDF from www.delconca.com

Technische Zeichnungen herunterladbar in DWG/PDF aus www.delconca.com
Téléchargez les dessins techniques en DWG/PDF de www.delconca.com

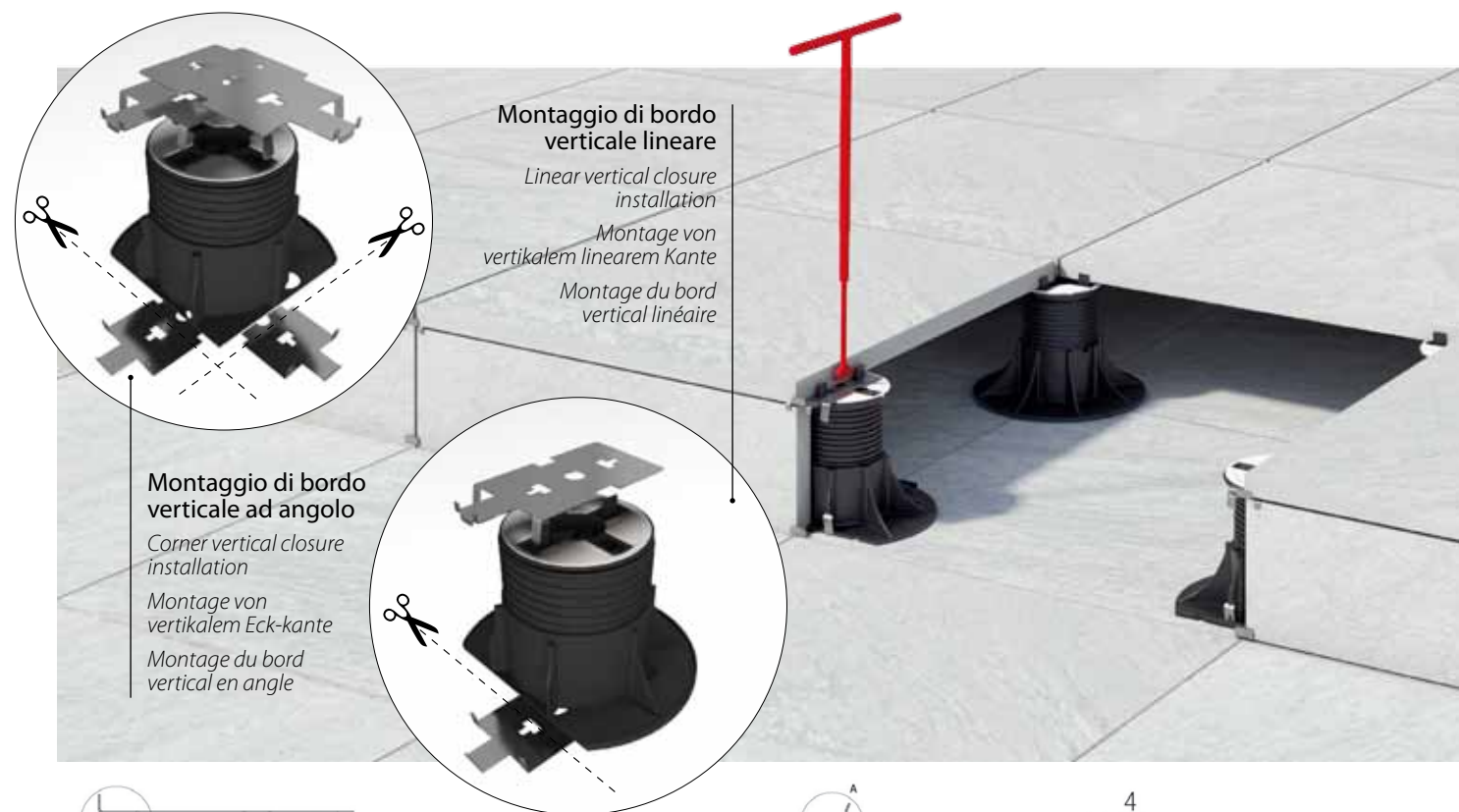

Montaggio di bordo verticale lineare
 Linear vertical closure installation
 Montage von vertikalem linearem Kante
 Montage du bord vertical linéaire

Montaggio di bordo verticale ad angolo
 Corner vertical closure installation
 Montage von vertikalem Eck-kante
 Montage du bord vertical en angle

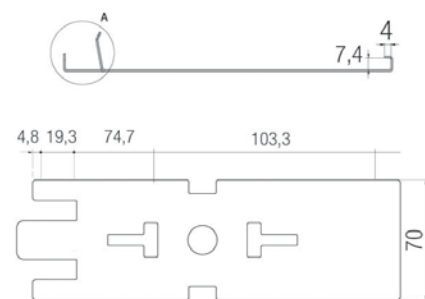
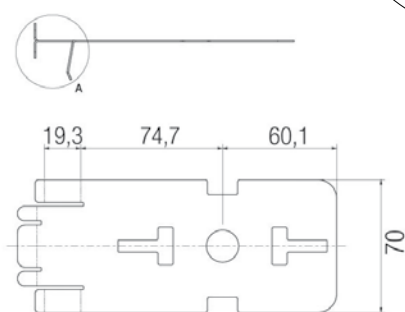

CLIP BORDO VERTICALE

L'innovazione sicura per "chiudere in bellezza".

Progettata per far fronte al tamponamento del bordo quando si è in assenza del muro perimetrale, la Clip bordo verticale costituisce un innovativo sistema che permette di chiudere facilmente ed elegantemente lo spazio perimetrale che si crea in presenza di pavimentazioni sopraelevate. Una soluzione composta di due particolari clips in acciaio inox che, messe sopra la testa e sotto la base del supporto, creano una sede con dei mordenti che incastrano la porzione di pavimentazione rifilata a misura dello spazio da tamponare, evitando in modo contestuale lo scivolamento delle piastre orizzontali grazie al blocco posto all'estremità della clip bordo pavimento.

CLIP FOR VERTICAL CLOSURE

The sure new way of finishing in style

Our clip for vertical closure is designed to solve a typical problem of many external floors, i.e. how to fill in the gap around the edge when no perimeter wall is present. This solution represents an innovative, easy and elegant way to eliminate gaps around raised floors. The system consists of two special, stainless steel clips to be placed over the head and under the base of the pedestal. It creates a firm seat capable of gripping the section of floor cut to size to fill the gap. The use of our floor edge clip effectively prevents horizontal movement in floor slabs.

VERTIKALE KANTEN-KLAMMER

Die sichere Innovation für einen schönen Abschluss

Die eigens für die Kantenabdichtung bei fehlender Umfassungsmauer, ein häufiges Problem vieler Bodenbeläge im Außenbereich, entwickelte Bodenkanten-Klammer ist ein innovatives System, das den umfangsseitigen Zwischenraum bei Systemböden einfach und elegant abschließt. Die Lösung beinhaltet zwei Spezialklammern aus Edelstahl, die jeweils auf dem Kopf und unter dem Halter einen Sitz bilden, in dem mit Beizen der Teil des auf den abzudichtenden Zwischenraum zugeschnittenen Bodenbelags festgeklemmt wird. Gleichzeitig wird dabei durch das endseitige Blocksystem der Bodenkanten-Klammer das Verrutschen der horizontalen Platten verhindert.

CLIP BORD VERTICAL

L'innovation sûre pour "finir en beauté"

Conçu pour résoudre un problème commun à de nombreux planchers pour l'extérieur, à savoir la finition du bord en l'absence de mur d'enceinte, le clip bord vertical représente un système innovant qui permet de fermer facilement et de manière élégante l'espace qui se crée sur le pourtour en présence de planchers surélevés. Cette solution est composée de deux clips particuliers en acier inox qui, mis sur la tête et sous la base du support, créent un support avec des dispositifs de fixation où va s'encasturer la portion de revêtement découpée à la mesure de l'espace à boucher, en évitant également le glissement des plaques horizontales, grâce au blocage situé à l'extrémité du clip bord vertical.



Posa sopraelevata in prossimità di un muro
 Raised installation next to a wall
 Verlegung als Doppelboden nahe bei der Mauer
 Pose surélevée à proximité d'un mur

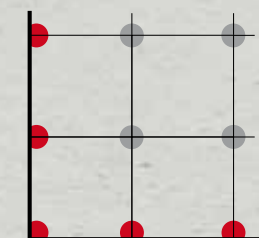

CLIP BORDO PIASTRA

La congiunzione ideale tra estetica e funzionalità

Ideata per evitare il contatto tra piastre e muro perimetrale nelle pavimentazioni sopraelevate da esterno, la Clip bordo piastra, costruita interamente in acciaio inox, è dotata di ammortizzatore per le dilatazioni longitudinali e trasversali e di un sicuro aggancio per consentire una fuga perimetrale lineare ed elegante, conferendo al contempo stabilità alla pavimentazione.

UNIVERSAL EDGE CLIP

The perfect join: attractive and functional

Designed to avoid contact between the slabs of outdoor raised floors and outside walls, the universal edge clip is made entirely from stainless steel. It incorporates a damper to absorb longitudinal and transverse thermal expansion and guarantees a secure grip. Use of these clips ensures a stable floor surface with a straight and elegant perimeter.

BODENKANTEN-KLAMMER

Die ideale Verbindung von Ästhetik und Funktionalität

Die gänzlich aus Edelstahl gefertigte Eterno Ivica Vertikale Kanten-Klammer verhindert den Kontakt zwischen Platten und Umfassungsmauer bei Systemböden für den Außenbereich. Die Klammer ist mit Dämpfer gegen längs- und querseitige Dehnungen sowie mit einer sicheren Befestigung ausgestattet, so dass eine lineare und elegante Umfassungsfuge realisierbar ist und dem Bodenbelag zugleich Stabilität verliehen wird.

CLIP BORD PLAQUE

L'union idéale entre esthétique et fonctionnalité

Conçu par Eterno Ivica pour éviter le contact entre les plaques et le mur d'enceinte dans les planchers surélevés pour l'extérieur, le clip bord plaque, entièrement construit en acier inox, est muni d'amortisseur pour les dilatations longitudinales et transversales et d'un système d'accrochage sûr pour permettre un joint périphérique linéaire et élégant, tout en assurant la stabilité du plancher.



Posa carrabile

Carriageable installation / Befahrbare Verlegung / Pose carrossable

due 2

Gli articoli Del Conca due2 di formato 20x20 e 40x40 presentano i più alti carichi di rottura e resistenza meccanica dell'intera gamma. Questi, abbinati ad una posa incollata su massetto, sono ideali per la realizzazione di vialetti ed aree carrabili piacevoli, durevoli, sicure. Il massetto cementizio deve essere realizzato a regola d'arte e le piastrelle due2 incollate con colla cementizia elastica per esterni, lasciando una fuga da 2 mm almeno e rispettando i giunti di dilatazione.

Del Conca's due2 products in 20x20 and 40x40 format have the highest tensile strength and mechanical resistance of the entire range. Combined with glue down laying onto the screed, they are ideal for the construction of attractive, durable and safe pathways and driveways. The cement screed must be laid perfectly and the due2 tiles glued with outdoor elastic cement adhesive, leaving a minimum gap of 2 mm and respecting the expansion joints.

Die Artikel Del Conca due2 im Format 20x20 und 40x40 zeichnen sich durch die höchste Bruchlast und die höchste mechanische Festigkeit des gesamten Sortiments aus. Diese, in Kombination mit einer Verlegung auf Estrich mit Kleber, eignen sich ideal zur Verwirklichung von schönen, langlebigen und sicheren Einfahrten und befahrbaren Bereichen. Der Zementestrich muss fachmännisch angefertigt werden und die Platten due2 mit elastischem Zementkleber für Außenbereiche aufgeklebt werden, wobei eine Fuge von mindestens 2 mm gelassen werden muss und die Dehnungsfugen einzuhalten sind.

Les articles Del Conca due2 au format 20x20 et 40x40 présentent les charges de rupture et de résistance mécanique les plus élevées de l'ensemble de la gamme. Ceux-ci, combinés avec une pose de colle sur la chape, sont parfaits pour la construction d'allées et de zones pour véhicules, agréables, durables et sécurisées. La chape de ciment doit être réalisée selon les règles de l'art et les carreaux due2 collés à l'aide d'une colle cimentaire flexible pour une utilisation en extérieur, laissant un espace d'au moins 2 mm et respectant les joints de dilatation.



due 2

Bordo naturale o rettificato?

Cammina sicuro con il bordo naturale!

Natural or rectified edges? - Walk safe with the natural edges!

Presskante oder rektifizierte Kante? – Sicher auf Presskanten laufen!

Bord naturel ou rectifié? – Promenez-vous en toute sûreté avec le bord naturel!

Per quasi tutte le applicazioni è preferibile il bordo naturale. Gli spazi esterni vanno vissuti in libertà, **due2** in versione naturale fornisce un bordo più confortevole per camminare scalzi, senza pregiudicare l'aspetto estetico; è inoltre più resistente alle sollecitazioni sul bordo.

In applicazioni sopraelevate o su massetto il bordo rettificato permette di ottenere fughe ancor più sottili.

*Natural edges are preferred for most applications. Outdoor spaces must be lived freely, and **due2** with natural edges provides a more comfortable edge to walk on barefoot, without affecting the aesthetic appearance; it is also more resistant to shocks on the edges.*

On raised installations or when installed with adhesive, the rectified edges allow for even thinner joints.

*In fast allen Fällen ist die Presskante besser. Im Aussenbereich sollte man Freizügigkeit genießen, **due2**-Terrassenplatte mit Presskanten wirkt sowohl komfortabler beim Barfuss-Laufen als auch schöner; zusätzlich bietet noch stärker Widerstand gerade im Kantenbereich. Bei Verlegung auf Stelzlager oder im Falle von geklebten Platten sind, bei rektifizierten Kanten, dünneren Fugen möglich.*

*Pour presque toutes les utilisations le bord naturel est préférable. Les espaces à l'extérieur doivent être vécus en tout liberté, **due2** en version naturel présente un bord plus confortable pour se promener pieds-nus, sans nuire à l'aspect esthétique; de plus, il est plus résistant aux sollicitations sur le bord. Pour des utilisations en pose surélevée ou sur chape le bord rectifié permet d'obtenir des joints plus serrés.*

3,5 mm

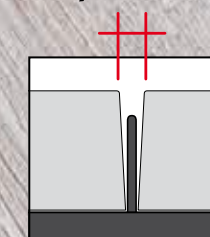

POSA SOPRAELEVATA BORDI NATURALI

RAISED INSTALLATION - NATURAL EDGES
VERLEGUNG ALS DOPPELBODEN
NATÜRLICHEN RÄNDERN
POSE SURÉLEVÉE - BORDS NATURELS

2 mm

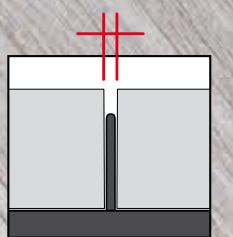

POSA SOPRAELEVATA BORDI RETTIFICATI

RAISED INSTALLATION - RECTIFIED EDGES
VERLEGUNG ALS DOPPELBODEN
REKTIFIZIERTEN RÄNDERN
POSE SURÉLEVÉE - BORDS RECTIFIÉS

Per fughe superiori a 3 mm non è necessaria la versione con bordi rettificati.

For joints thicker than 3 mm it is not necessary to use the version with rectified edges.

Mit mehr als 3 mm breiten Fugen, sind rektifizierte Kanten überhaupt nicht notwendig.

Pour des joints supérieurs à 3 mm il n'est pas nécessaire la version rectifiée.

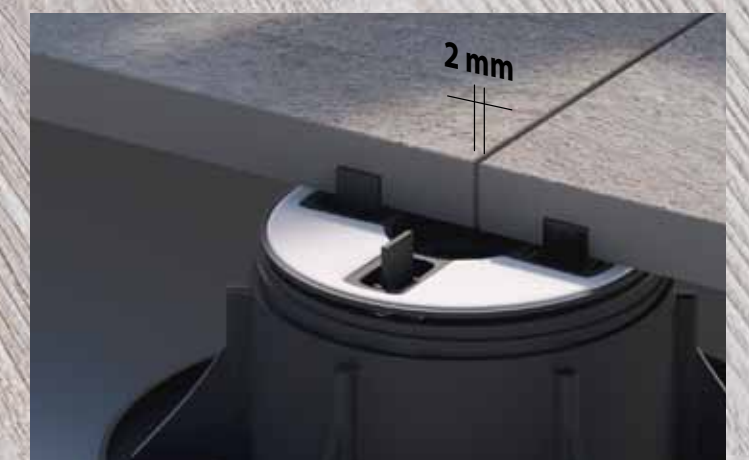
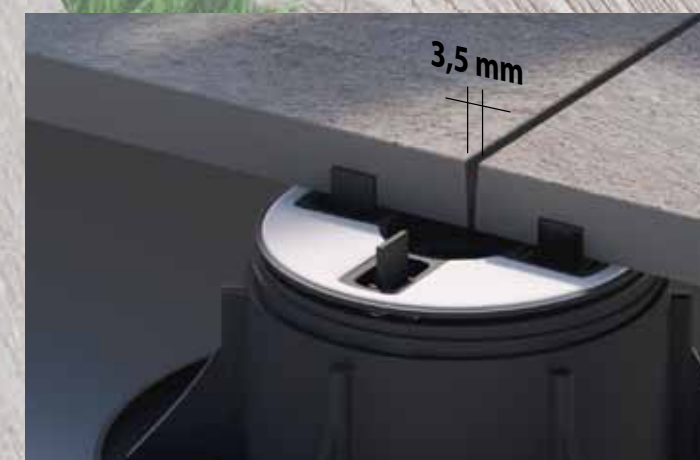



due 2

Una vasta gamma di prodotti in spessore 20 mm spesso coordinati con articoli da interno.

A wide range of 20 mm thick products often with a matching version for interiors.

Une vaste gamme de produits d'une épaisseur de 20 mm souvent en combinaison avec les articles pour intérieur correspondants

Ein breit gefächertes Angebot an Produkten mit einer Stärke von 20 mm, häufig mit den entsprechenden Artikeln für den Innenbereich



HFR 201
40x80 cm 16x32 in
129



HFR 205
40x80 cm 16x32 in
129



HFR 208
40x80 cm 16x32 in
129

Per la posa incollata si consiglia
una fuga minima di 5 mm
*A 5mm minimum joint
is recommended*
*Es wird eine Fuge von mindestens
5 Mm empfohlen*
*On conseille une pose avec un joint
de minimum 5mm*

Prodotto non calibrato Product not calibrated · Nicht nachkalibriertes Produkt · Produit non calibré



20mm due²

HFR 201



HFR 205

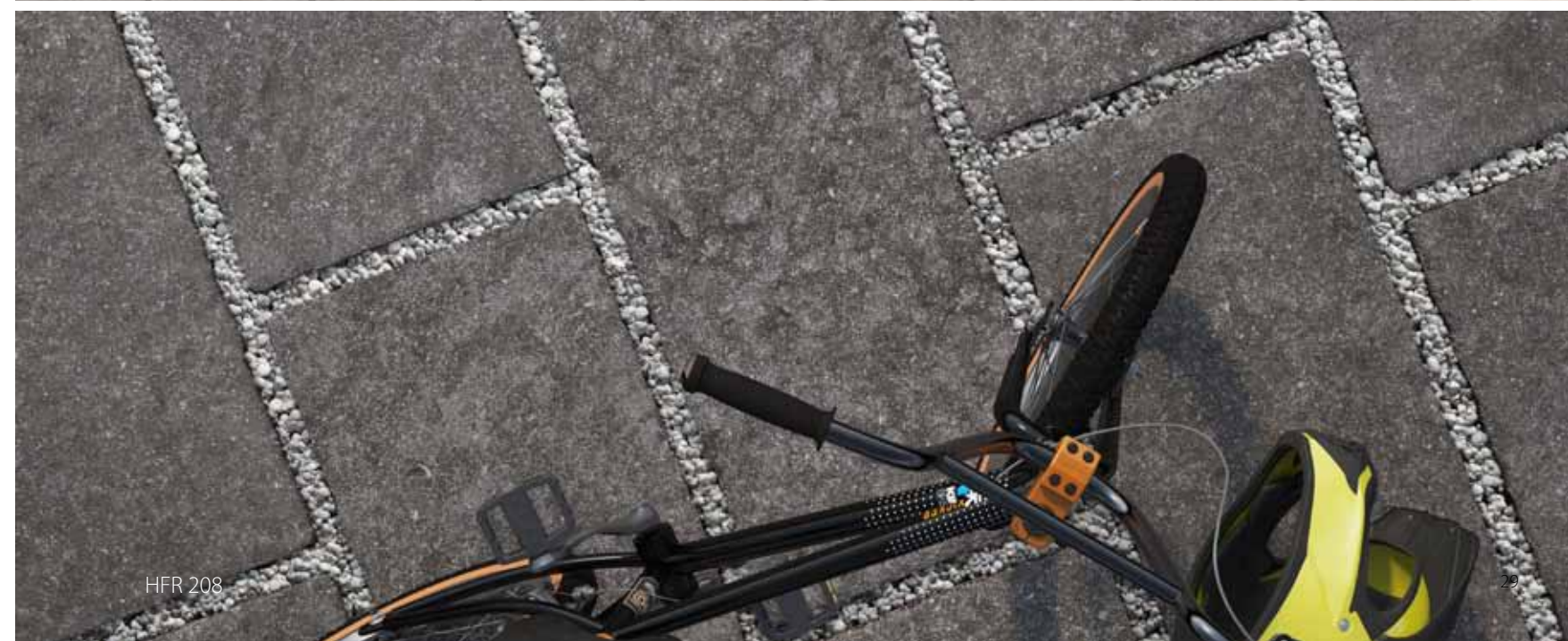

HFR 208

NEW SIZE



HBO 205
60x90 cm 24x36 in

HBO 205 Rett.
60x90 cm 24x36 in

NEW SIZE



HBO 208
60x90 cm 24x36 in

HBO 208 Rett.
60x90 cm 24x36 in

Bordo naturale o rettificato?
Leggi a pagina 24





Natural or rectified edges?
Read on page 24

Presskante oder rektifizierte Kante?
Bitte siehe Seite 24





Bord naturel ou rectifié?
Voir page 24

Pezzi Speciali Special Pieces • Formteile • Pièces Spéciales

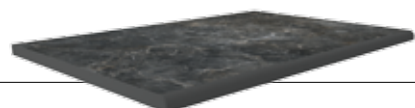





Gradone Lineare / HBO 205
 
Gradone Lineare Rett. / HBO 205
 
Step / Stufe / Nez de marche
60x90 cm 24x36 in





Gradone Lineare / HBO 208
 
Gradone Lineare Rett. / HBO 208
 
Step / Stufe / Nez de marche
60x90 cm 24x36 in

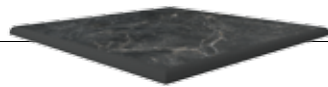

Gradone Angolare / HBO 205
 
Gradone Angolare Rett. / HBO 205
 
Corner Step / Eckstufe / Nez de marche angulaire
60x60 cm 24x24 in



Gradone Angolare / HBO 208
 
Gradone Angolare Rett. / HBO 208
 
Corner Step / Eckstufe / Nez de marche angulaire
60x60 cm 24x24 in

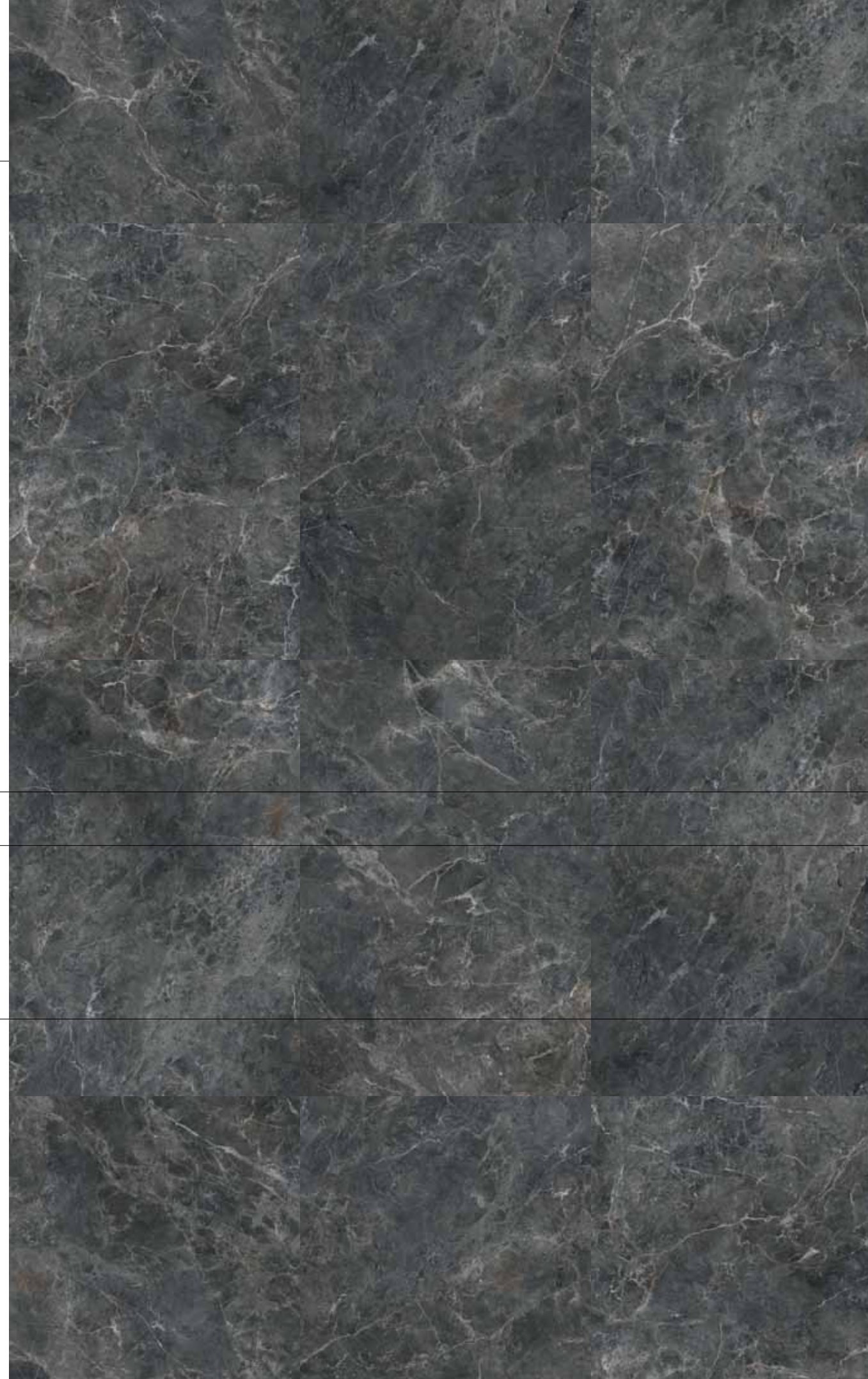

NEW SIZE



HQZ 205
60x90 cm 24x36 in
137

HQZ 205 Rett.
60x90 cm 24x36 in
156

Bordo naturale o rettificato? Leggi a pagina 24
Natural or rectified edges? Read on page 24
Presskante oder rektifizierte Kante? Bitte siehe Seite 24
Bord naturel ou rectifié? Voir page 24

Pezzi Speciali Special Pieces • Formteile • Pièces Spéciales

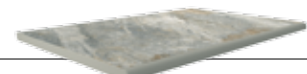

Gradone Lineare / HQZ 205
163
Gradone Lineare Rett. / HQZ 205
175
Step / Stufe / Nez de marche
60x90 cm 24x36 in



Gradone Angolare / HQZ 205
203
Gradone Angolare Rett. / HQZ 205
215
Corner Step / Eckstufe / Nez de marche angulaire
60x60 cm 24x24 in



HVG 211
60x60 cm 24x24 in
118

HVG 211 Rett.
60x60 cm 24x24 in
131

Bordo naturale o rettificato?
Leggi a pagina 24
Natural or rectified edges?
Read on page 24
Presskante oder rektifizierte Kante?
Bitte siehe Seite 24
Bord naturel ou rectifié?
Voir page 24



HVG 211
40x80 cm 16x32 in
127

HVG 211 Rett.
40x80 cm 16x32 in
140

Pezzi Speciali Special Pieces • Formteile • Pièces Spéciales



Gradone Lineare / HVG 211
097
Gradone Lineare Rett. / HVG 211
110
Step / Stufe / Nez de marche
60x60 cm 24x24 in



Gradone Lineare / HVG 211
109
Gradone Lineare Rett. / HVG 211
120
Step / Stufe / Nez de marche
40x80 cm 16x32 in



Gradone Angolare / HVG 211
120
Gradone Angolare Rett. / HVG 211
134
Corner Step / Eckstufe / Nez de marche angulaire
60x60 cm 24x24 in

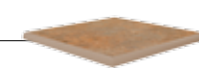

Gradone Angolare / HVG 211
097
Gradone Angolare Rett. / HVG 211
104
Corner Step / Eckstufe / Nez de marche angulaire
40x40 cm 16x16 in





HVG 210
60x60 cm 24x24 in
□118

HVG 210 Rett.
60x60 cm 24x24 in
□131 



HVG 209
60x60 cm 24x24 in
□118

HVG 210 209.
60x60 cm 24x24 in
□131 

Bordo naturale o rettificato?
Leggi a pagina 24
Natural or rectified edges?
Read on page 24
Presskante oder rektifizierte Kante?
Bitte siehe Seite 24
Bord naturel ou rectifié?
Voir page 24



HVG 210
40x80 cm 16x32 in
□127

HVG 210 Rett.
40x80 cm 16x32 in
□140 



HVG 209
40x80 cm 16x32 in
□127

HVG 209 Rett.
40x80 cm 16x32 in
□140 



Pezzi Speciali Special Pieces • Formteile • Pièces Spéciales



Gradone Lineare / HVG 210

□097 

Gradone Lineare Rett. / HVG 210

□110  



Step / Stufe / Nez de marche
60x60 cm 24x24 in



Gradone Lineare / HVG 210

□109 

Gradone Lineare Rett. / HVG 210

□120  

Step / Stufe / Nez de marche
40x80 cm 16x32 in



Gradone Lineare / HVG 209

□097 

Gradone Lineare Rett. / HVG 209

□110  



Step / Stufe / Nez de marche
60x60 cm 24x24 in



Gradone Lineare / HVG 209

□109 

Gradone Lineare Rett. / HVG 209

□120  

Step / Stufe / Nez de marche
40x80 cm 16x32 in



Gradone Angolare / HVG 210

□120 

Gradone Angolare Rett. / HVG 210

□134  



Corner Step / Eckstufe / Nez de marche angulaire
60x60 cm 24x24 in



Gradone Angolare / HVG 210

□097 

Gradone Angolare Rett. / HVG 210

□104  



Corner Step / Eckstufe / Nez de marche angulaire
40x40 cm 16x16 in



Gradone Angolare / HVG 209

□120 

Gradone Angolare Rett. / HVG 209

□134  

Corner Step / Eckstufe / Nez de marche angulaire
60x60 cm 24x24 in



Gradone Angolare / HVG 209

□097 

Gradone Angolare Rett. / HVG 209

□104  

Corner Step / Eckstufe / Nez de marche angulaire
40x40 cm 16x16 in





HDG 201
60x120 cm 24x48 in
154



HDG 201 Rett.
60x120 cm 24x48 in
171



HDG 205
60x120 cm 24x48 in
154

HDG 205 Rett.
60x120 cm 24x48 in
171

HDG 215
60x120 cm 24x48 in
154

HDG 215 Rett.
60x120 cm 24x48 in
171



HDG 201 Rett.
30x120 cm 12x48 in
191



HDG 205 Rett.
30x120 cm 12x48 in
191



HDG 215 Rett.
30x120 cm 12x48 in
191



Pezzi Speciali Special Pieces • Formteile • Pièces Spéciales



Gradone Lineare / HDG 201
268
Gradone Lineare Rett. / HDG 201
293
Step / Stufe / Nez de marche
60x120 cm 24x48 in



Gradone Lineare / HDG 205
268
Gradone Lineare Rett. / HDG 205
293
Step / Stufe / Nez de marche
60x120 cm 24x48 in



Gradone Lineare / HDG 215
268
Gradone Lineare Rett. / HDG 215
293
Step / Stufe / Nez de marche
60x120 cm 24x48 in

Bordo naturale o rettificato?
Leggi a pagina 24

Natural or rectified edges?
Read on page 24

Presskante oder rektifizierte Kante?
Bitte siehe Seite 24

Bord naturel ou rectifié?
Voir page 24



HEG 205
60x120 cm 24x48 in
154



HEG 205 Rett.
60x120 cm 24x48 in
171



HEG 205
40x80 cm 16x32 in
127

HEG 205 Rett.
40x80 cm 16x32 in
140



HEG 208
60x120 cm 24x48 in
154



HEG 208
40x80 cm 16x32 in
127

HEG 208 Rett.
60x120 cm 24x48 in
171

HEG 208 Rett.
40x80 cm 16x32 in
140



Bordo naturale o rettificato?
Leggi a pagina 24
Natural or rectified edges?
Read on page 24
Presskante oder rektifizierte Kante?
Bitte siehe Seite 24
Bord naturel ou rectifié?
Voir page 24

Pezzi Speciali Special Pieces • Formteile • Pièces Spéciales

Pezzi Speciali Special Pieces • Formteile • Pièces Spéciales



Gradone Lineare / HEG 205
109
Gradone Lineare Rett. / HEG 205
120
Step / Stufe / Nez de marche
40x80 cm 16x32 in



Gradone Angolare/HEG 205 (DX-R)
Gradone Angolare/HEG 205 (SX-L)
097
Gradone Angolare Rett./HEG 205 (DX-R)
Gradone Angolare Rett./HEG 205 (SX-L)
104
Corner Step / Eckstufe / Nez de marche angulaire
40x40 cm 16x16 in



Gradone Lineare / HEG 205
268
Gradone Lineare Rett. / HEG 205
293
Step / Stufe / Nez de marche
60x120 cm 24x48 in



Gradone Lineare / HEG 208
109
Gradone Lineare Rett. / HEG 208
120
Step / Stufe / Nez de marche
40x80 cm 16x32 in

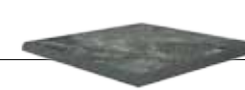

Gradone Angolare/HEG 208 (DX-R)
Gradone Angolare/HEG 208 (SX-L)
097
Gradone Angolare Rett./HEG 208 (DX-R)
Gradone Angolare Rett./HEG 208 (SX-L)
104
Corner Step / Eckstufe / Nez de marche angulaire
40x40 cm 16x16 in

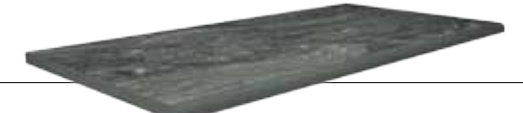

Gradone Lineare / HEG 208
268
Gradone Lineare Rett. / HEG 208
293
Step / Stufe / Nez de marche
60x120 cm 24x48 in

Disponibile in composizione modulare (p. 80)
Available in modular pattern (p. 80) • In modularer Zusammensetzung vorraetig (p. 80) • Disponible en pose modulaire (p. 80)



HAV 201
60x120 cm 24x48 in
154



HAV 201 Rett.
60x120 cm 24x48 in
171



HAV 201
60x60 cm 24x24 in
127

HAV 201 Rett.
60x60 cm 24x24 in
140

Pezzi Speciali Special Pieces • Formteile • Pièces Spéciales



Gradone Lineare / HAV 201
268
Gradone Lineare Rett. / HAV 201
293
Step / Stufe / Nez de marche
60x120 cm 24x48 in



Gradone Lineare / HAV 201
097
Gradone Lineare Rett. / HAV 201
110
Step / Stufe / Nez de marche
60x60 cm 24x24 in



Gradone Angolare / HAV 201
120
Gradone Angolare Rett. / HAV 201
134
Corner Step / Eckstufe / Nez de marche angulaire
60x60 cm 24x24 in



HAV 209
60x120 cm 24x48 in
154



HAV 209 Rett.
60x120 cm 24x48 in
171

HAV 209
60x60 cm 24x24 in
127

HAV 209 Rett.
60x60 cm 24x24 in
140

Bordo naturale o rettificato?
Leggi a pagina 24
Natural or rectified edges?
Read on page 24
Presskante oder rektifizierte Kante?
Bitte siehe Seite 24
Bord naturel ou rectifié?
Voir page 24



Pezzi Speciali Special Pieces • Formteile • Pièces Spéciales



Gradone Lineare / HAV 209
268
Gradone Lineare Rett. / HAV 209
293
Step / Stufe / Nez de marche
60x120 cm 24x48 in



Gradone Lineare / HAV 209
097
Gradone Lineare Rett. / HAV 209
110
Step / Stufe / Nez de marche
60x60 cm 24x24 in



Gradone Angolare / HAV 209
120
Gradone Angolare Rett. / HAV 209
134
Corner Step / Eckstufe / Nez de marche angulaire
60x60 cm 24x24 in



HAV 205
60x120 cm 24x48 in
154



HAV 205 Rett.
60x120 cm 24x48 in
171



HAV 205
60x60 cm 24x24 in
127

HAV 205 Rett.
60x60 cm 24x24 in
140

Pezzi Speciali Special Pieces • Formteile • Pièces Spéciales



Gradone Lineare / HAV 205
268
Gradone Lineare Rett. / HAV 205
293
Step / Stufe / Nez de marche
60x120 cm 24x48 in

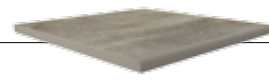

Gradone Lineare / HAV 205
097
Gradone Lineare Rett. / HAV 205
110
Step / Stufe / Nez de marche
60x60 cm 24x24 in



Gradone Angolare / HAV 205
120
Gradone Angolare Rett. / HAV 205
134
Corner Step / Eckstufe / Nez de marche angulaire
60x60 cm 24x24 in



HAV 208
60x120 cm 24x48 in
154



HAV 208 Rett.
60x120 cm 24x48 in
171

HAV 208
60x60 cm 24x24 in
127

HAV 208 Rett.
60x60 cm 24x24 in
140

Bordo naturale o rettificato?
Leggi a pagina 24
Natural or rectified edges?
Read on page 24
Presskante oder rektifizierte Kante?
Bitte siehe Seite 24
Bord naturel ou rectifié?
Voir page 24



Pezzi Speciali Special Pieces • Formteile • Pièces Spéciales



Gradone Lineare / HAV 208
268
Gradone Lineare Rett. / HAV 208
293
Step / Stufe / Nez de marche
60x120 cm 24x48 in



Gradone Lineare / HAV 208
097
Gradone Lineare Rett. / HAV 208
110
Step / Stufe / Nez de marche
60x60 cm 24x24 in



Gradone Angolare / HAV 208
120
Gradone Angolare Rett. / HAV 208
134
Corner Step / Eckstufe / Nez de marche angulaire
60x60 cm 24x24 in



HMN 205
40x120 cm 16x48 in
150

HMN 205 Rett.
40x120 cm 16x48 in
169



HMN 201
40x120 cm 16x48 in
150

HMN 201 Rett.
40x120 cm 16x48 in
169



HMN 209
40x120 cm 16x48 in
150

HMN 209 Rett.
40x120 cm 16x48 in
169

Bordo naturale o rettificato?
Leggi a pagina 24

Natural or rectified edges?
Read on page 24

Presskante oder rektifizierte Kante?
Bitte siehe Seite 24

Bord naturel ou rectifié?
Voir page 24

Pezzi Speciali

Special Pieces • Formteile • Pièces Spéciales



Gradone Lineare / HMN 205
207
Gradone Lineare Rett. / HMN 205
221
Step / Stufe / Nez de marche
40x120 cm 16x48 in



Gradone Lineare / HMN 201
207
Gradone Lineare Rett. / HMN 201
221
Step / Stufe / Nez de marche
40x120 cm 16x48 in



Gradone Lineare / HMN 209
207
Gradone Lineare Rett. / HMN 209
221
Step / Stufe / Nez de marche
40x120 cm 16x48 in





HDL 201
40x120 cm 16x48 in
150

HDL 201 Rett.
40x120 cm 16x48 in
169



HDL 205
40x120 cm 16x48 in
150

HDL 205 Rett.
40x120 cm 16x48 in
169



HDL 209
40x120 cm 16x48 in
150

HDL 209 Rett.
40x120 cm 16x48 in
169



HDL 203
40x120 cm 16x48 in
150

HDL 203 Rett.
40x120 cm 16x48 in
169



Pezzi Speciali Special Pieces • Formteile • Pièces Spéciales



Gradone Lineare / HDL 201
207
Gradone Lineare Rett. / HDL 201
221
Step / Stufe / Nez de marche
40x120 cm 16x48 in



Gradone Lineare / HDL 205
207
Gradone Lineare Rett. / HDL 205
221
Step / Stufe / Nez de marche
40x120 cm 16x48 in



Gradone Lineare / HDL 209
207
Gradone Lineare Rett. / HDL 209
221
Step / Stufe / Nez de marche
40x120 cm 16x48 in



Gradone Lineare / HDL 203
207
Gradone Lineare Rett. / HDL 203
221
Step / Stufe / Nez de marche
40x120 cm 16x48 in



HED 211
80x80 cm 32x32 in
154

HED 211 Rett.
80x80 cm 32x32 in
171



Pezzi Speciali Special Pieces • Formteile • Pièces Spéciales



Gradone Lineare / HED 211
227
Gradone Lineare Rett. / HED 211
247
Step / Stufe / Nez de marche
80x80 cm 32x32 in

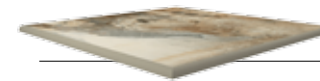

Gradone Angolare / HED 211
317
Gradone Angolare Rett. / HED 211
317
Corner Step / Eckstufe / Nez de marche angulaire
80x80 cm 32x32 in

Bordo naturale o rettificato?
Leggi a pagina 24

Natural or rectified edges?
Read on page 24

Presskante oder rektifizierte Kante?
Bitte siehe Seite 24

Bord naturel ou rectifié?
Voir page 24

Disponibile in composizione modulare (p. 82)
Available in modular pattern (p. 82) • In modularer Zusammensetzung vorraetig (p. 82) • Disponible en pose modulaire (p. 82)



HSC 210
80x80 cm 32x32 in
154

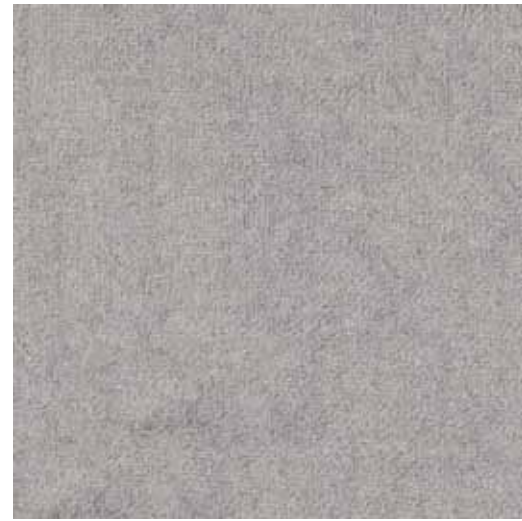

HSC 205
80x80 cm 32x32 in
154

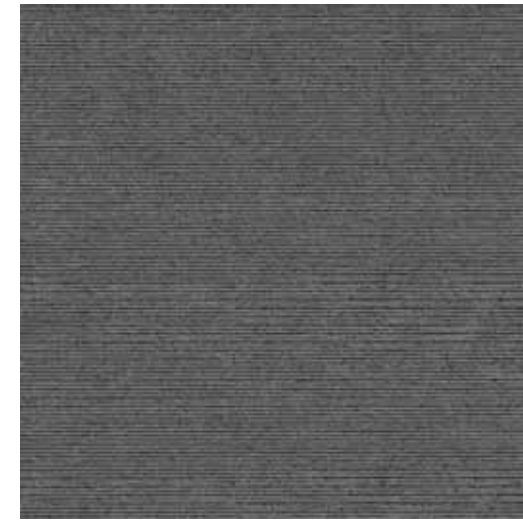

HSC 208
80x80 cm 32x32 in
154

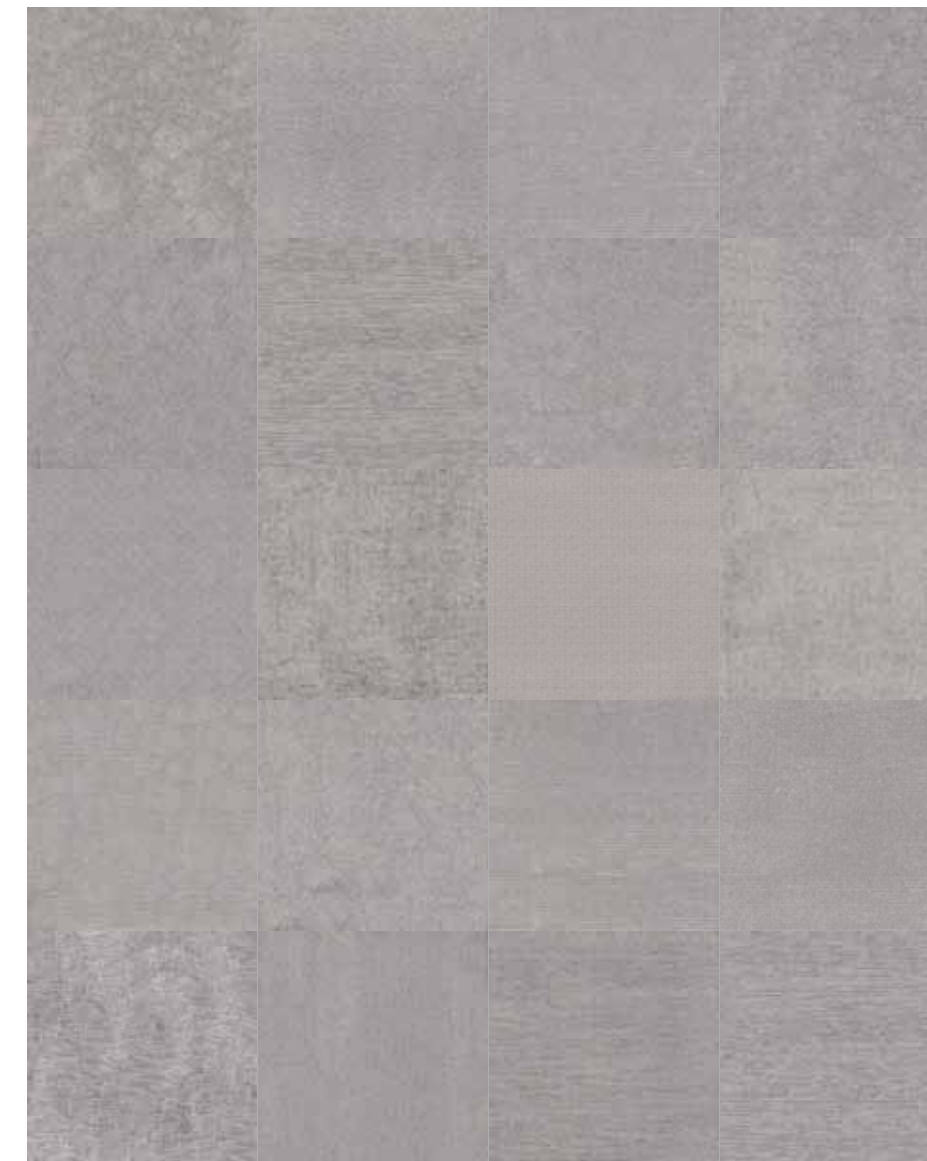

HSC 210
60x60 cm 24x24 in
118



HSC 205
60x60 cm 24x24 in
118

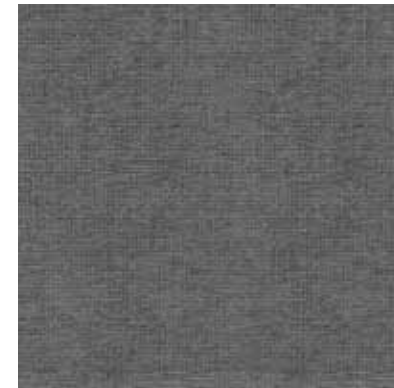

HSC 208
60x60 cm 24x24 in
118

Bordo naturale o rettificato?
Leggi a pagina 24
Natural or rectified edges?
Read on page 24
Presskante oder rektifizierte Kante?
Bitte siehe Seite 24
Bord naturel ou rectifié?
Voir page 24

Pezzi Speciali Special Pieces • Formteile • Pièces Spéciales

Pezzi Speciali Special Pieces • Formteile • Pièces Spéciales



Gradone Lineare / HSC 210
0227
Gradone Lineare Rett. / HSC 210
0247
Step / Stufe / Nez de marche
80x80 cm 32x32 in



Gradone Lineare / HSC 210
0097
Gradone Lineare Rett. / HSC 210
0110
Step / Stufe / Nez de marche
60x60 cm 24x24 in



Gradone Lineare / HSC 205
0227
Gradone Lineare Rett. / HSC 205
0247
Step / Stufe / Nez de marche
80x80 cm 32x32 in



Gradone Lineare / HSC 205
0097
Gradone Lineare Rett. / HSC 205
0110
Step / Stufe / Nez de marche
60x60 cm 24x24 in

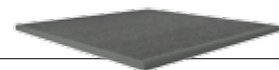

Gradone Lineare / HSC 208
0227
Gradone Lineare Rett. / HSC 208
0247
Step / Stufe / Nez de marche
80x80 cm 32x32 in

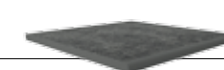

Gradone Lineare / HSC 208
0097
Gradone Lineare Rett. / HSC 208
0110
Step / Stufe / Nez de marche
60x60 cm 24x24 in



Gradone Angolare / HSC 210
0317
Gradone Angolare Rett. / HSC 210
0317
Corner Step / Eckstufe / Nez de marche angulaire
80x80 cm 32x32 in



Gradone Angolare / HSC 210
0120
Gradone Angolare Rett. / HSC 210
0134
Corner Step / Eckstufe / Nez de marche angulaire
60x60 cm 24x24 in



Gradone Angolare / HSC 205
0317
Gradone Angolare Rett. / HSC 205
0317
Corner Step / Eckstufe / Nez de marche angulaire
80x80 cm 32x32 in



Gradone Angolare / HSC 205
0120
Gradone Angolare Rett. / HSC 205
0134
Corner Step / Eckstufe / Nez de marche angulaire
60x60 cm 24x24 in

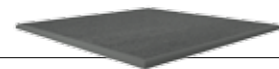

Gradone Angolare / HSC 208
0317
Gradone Angolare Rett. / HSC 208
0317
Corner Step / Eckstufe / Nez de marche angulaire
80x80 cm 32x32 in

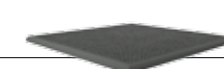

Gradone Angolare / HSC 208
0120
Gradone Angolare Rett. / HSC 208
0134
Corner Step / Eckstufe / Nez de marche angulaire
60x60 cm 24x24 in



HCL 210
80x80 cm
32x32 in
□154

HCL 210 Rett.
80x80 cm
32x32 in
□171



HCL 209
80x80 cm
32x32 in
□154

HCL 209 Rett.
80x80 cm
32x32 in
□171



HCL 205
80x80 cm
32x32 in
□154

HCL 205 Rett.
80x80 cm
32x32 in
□171



HCL 208
80x80 cm
32x32 in
□154

HCL 208 Rett.
80x80 cm
32x32 in
□171

Pezzi Speciali Special Pieces • Formteile • Pièces Spéciales



Gradone Lineare / HCL 210
□227
Gradone Lineare Rett. / HCL 210
□247
Step / Stufe / Nez de marche
80x80 cm 32x32 in

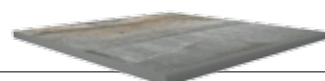

Gradone Lineare / HCL 205
□227
Gradone Lineare Rett. / HCL 205
□247
Step / Stufe / Nez de marche
80x80 cm 32x32 in



Gradone Lineare / HCL 209
□227
Gradone Lineare Rett. / HCL 209
□247
Step / Stufe / Nez de marche
80x80 cm 32x32 in

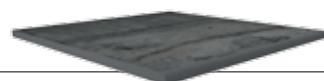

Gradone Lineare / HCL 208
□227
Gradone Lineare Rett. / HCL 208
□247
Step / Stufe / Nez de marche
80x80 cm 32x32 in



Gradone Angolare / HCL 210
□317
Gradone Angolare Rett. / HCL 210
□317
Corner Step / Eckstufe / Nez de marche angulaire
80x80 cm 32x32 in

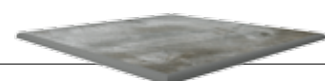

Gradone Angolare / HCL 205
□317
Gradone Angolare Rett. / HCL 205
□317
Corner Step / Eckstufe / Nez de marche angulaire
80x80 cm 32x32 in



Gradone Angolare / HCL 209
□317
Gradone Angolare Rett. / HCL 209
□317
Corner Step / Eckstufe / Nez de marche angulaire
80x80 cm 32x32 in

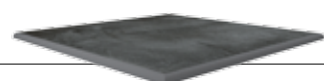

Gradone Angolare / HCL 208
□317
Gradone Angolare Rett. / HCL 208
□317
Corner Step / Eckstufe / Nez de marche angulaire
80x80 cm 32x32 in

Bordo naturale o rettificato?
Leggi a pagina 24

Natural or rectified edges?
Read on page 24

Presskante oder rektifizierte Kante?
Bitte siehe Seite 24

Bord naturel ou rectifié?
Voir page 24



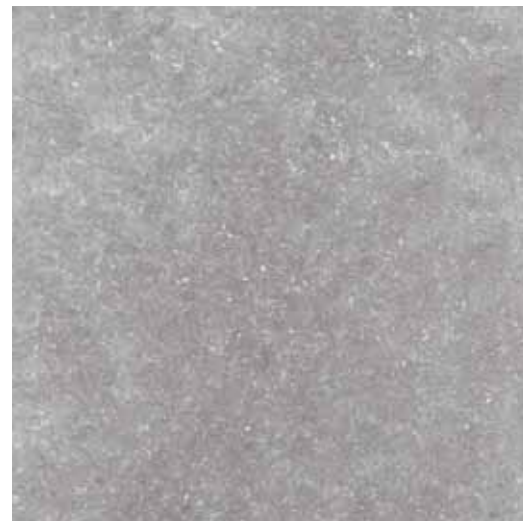

HBP 205
80x80 cm 32x32 in
154

HBP 205 Rett.
80x80 cm 32x32 in
171

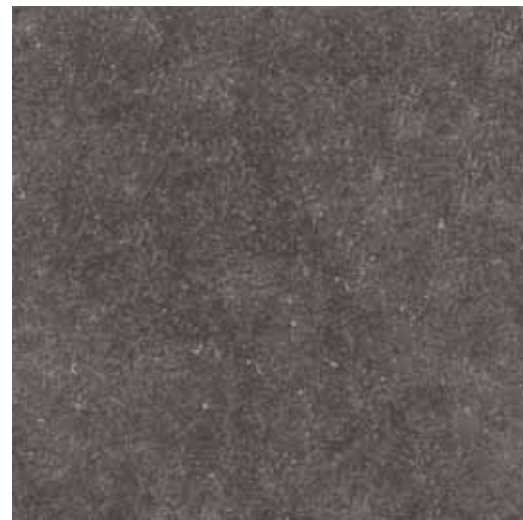

HBP 208
80x80 cm 32x32 in
154

HBP 208 Rett.
80x80 cm 32x32 in
171



HBQ 205
60x60 cm 24x24 in
118

HBQ 205 Rett.
60x60 cm 24x24 in
131



HBQ 208
60x60 cm 24x24 in
118

HBQ 208 Rett.
60x60 cm 24x24 in
131



Pezzi Speciali Special Pieces • Formteile • Pièces Spéciales



Gradone Lineare / HBP 205
227
Gradone Lineare Rett. / HBP 205
247
Step / Stufe / Nez de marche
80x80 cm 32x32 in

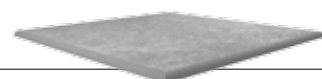

Gradone Angolare / HBP 205
317
Gradone Angolare Rett. / HBP 205
317
Corner Step / Eckstufe / Nez de marche angulaire
80x80 cm 32x32 in

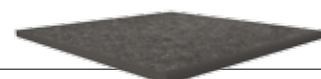

Gradone Lineare / HBP 208
227
Gradone Lineare Rett. / HBP 208
247
Step / Stufe / Nez de marche
80x80 cm 32x32 in



Gradone Angolare / HBP 208
317
Gradone Angolare Rett. / HBP 208
317
Corner Step / Eckstufe / Nez de marche angulaire
80x80 cm 32x32 in



Gradone Lineare / HBQ 205
097
Gradone Lineare Rett. / HBQ 205
110
Step / Stufe / Nez de marche
60x60 cm 24x24 in



Gradone Angolare / HBQ 205
120
Gradone Angolare Rett. / HBQ 205
134
Corner Step / Eckstufe / Nez de marche angulaire
60x60 cm 24x24 in



Gradone Lineare / HBQ 208
097
Gradone Lineare Rett. / HBQ 208
110
Step / Stufe / Nez de marche
60x60 cm 24x24 in



Gradone Angolare / HBQ 208
120
Gradone Angolare Rett. / HBQ 208
134
Corner Step / Eckstufe / Nez de marche angulaire
60x60 cm 24x24 in

Disponibile in composizione modulare (p. 86)
Available in modular pattern (p. 86) • In modularer Zusammensetzung vorraetig (p. 86) • Disponible en pose modulaire (p. 86)

Bordo naturale o rettificato?
Leggi a pagina 24

Natural or rectified edges?
Read on page 24

Presskante oder rektifizierte Kante?
Bitte siehe Seite 24

Bord naturel ou rectifié?
Voir page 24



HUP 210
 80x80 cm 32x32 in
 **154**

HUP 210 Rett.
 80x80 cm 32x32 in
 **171**



HUP 205
 80x80 cm 32x32 in
 **154**

HUP 205 Rett.
 80x80 cm 32x32 in
 **171**



HUP 210
 40x40 cm 16x16 in
 **118**

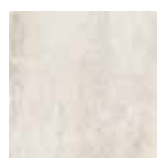

HUP 210
 20x20 cm 8x8 in
 **118**



HUP 205
 40x40 cm 16x16 in
 **118**



HUP 205
 20x20 cm 8x8 in
 **118**

Bordo naturale o rettificato?
 Leggi a pagina 24



Natural or rectified edges?
 Read on page 24

Presskante oder rektifizierte Kante?
 Bitte siehe Seite 24

Bord naturel ou rectifié?
 Voir page 24

Pezzi Speciali Special Pieces • Formteile • Pièces Spéciales





Gradone Lineare / HUP 210
 **227**
Gradone Lineare Rett. / HUP 210
 **247**
 Step / Stufe / Nez de marche
 80x80 cm 32x32 in



Gradone Lineare / HUP 210
 **055**
 Step / Stufe / Nez de marche
 40x40 cm 16x16 in





Gradone Lineare / HUP 205
 **227**
Gradone Lineare Rett. / HUP 205
 **247**
 Step / Stufe / Nez de marche
 80x80 32"x32"



Gradone Lineare / HUP 205
 **055**
 Step / Stufe / Nez de marche
 40x40 cm 16x16 in





Gradone Angolare / HUP 210
 **317**
Gradone Angolare Rett. / HUP 210
 **317**
 Corner Step / Eckstufe / Nez de marche angulaire
 80x80 cm 32x32 in



Gradone Angolare / HUP 210
 **097**
 Step / Stufe / Nez de marche
 40x40 cm 16x16 in



Gradone Angolare / HUP 205
 **317**
Gradone Angolare Rett. / HUP 205
 **317**
 Corner Step / Eckstufe / Nez de marche angulaire
 80x80 32"x32"



Gradone Angolare / HUP 205
 **097**
 Step / Stufe / Nez de marche
 40x40 cm 16x16 in





HUP 215
 80x80 cm 32x32 in
 154



HUP 209
 80x80 cm 32x32 in
 154

HUP 215 Rett.
 80x80 cm 32x32 in
 171

HUP 209 Rett.
 80x80 cm 32x32 in
 171



HUP 215
 40x40 cm 16x16 in
 118



HUP 215
 20x20 cm 8x8 in
 118



HUP 209
 40x40 cm 16x16 in
 118

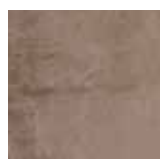

HUP 209
 20x20 cm 8x8 in
 118

Bordo naturale o rettificato?
Leggi a pagina 24



Natural or rectified edges?
Read on page 24

Presskante oder rektifizierte Kante?
Bitte siehe Seite 24

Bord naturel ou rectifié?
Voir page 24

Pezzi Speciali Special Pieces • Formteile • Pièces Spéciales





Gradone Lineare / HUP 215
 227
Gradone Lineare Rett. / HUP 215
 247
 Step / Stufe / Nez de marche
 80x80 cm 32x32 in



Gradone Lineare / HUP 215
 055
 Step / Stufe / Nez de marche
 40x40 cm 16x16 in





Gradone Lineare / HUP 209
 227
Gradone Lineare Rett. / HUP 209
 247
 Step / Stufe / Nez de marche
 80x80 cm 32x32 in



Gradone Lineare / HUP 209
 055
 Step / Stufe / Nez de marche
 40x40 cm 16x16 in





Gradone Angolare / HUP 215
 317
Gradone Angolare Rett. / HUP 215
 317
 Corner Step / Eckstufe / Nez de marche angulaire
 80x80 cm 32x32 in



Gradone Angolare / HUP 215
 097
 Step / Stufe / Nez de marche
 40x40 cm 16x16 in



Gradone Angolare / HUP 209
 317
Gradone Angolare Rett. / HUP 209
 317
 Corner Step / Eckstufe / Nez de marche angulaire
 80x80 cm 32x32 in



Gradone Angolare / HUP 209
 097
 Step / Stufe / Nez de marche
 40x40 cm 16x16 in





HNT 210
60x60 cm 24x24 in
118



HNT 205
60x60 cm 24x24 in
118



HNT 208
60x60 cm 24x24 in
118

HNT 210 Rett.
60x60 cm 24x24 in
131

HNT 205 Rett.
60x60 cm 24x24 in
131

HNT 208 Rett.
60x60 cm 24x24 in
131

Pezzi Speciali Special Pieces • Formteile • Pièces Spéciales



Gradone Lineare / HNT 210
097
Gradone Lineare Rett. / HNT 210
110
Step / Stufe / Nez de marche
60x60 cm 24x24 in



Gradone Lineare / HNT 205
097
Gradone Lineare Rett. / HNT 205
110
Step / Stufe / Nez de marche
60x60 cm 24x24 in



Gradone Lineare / HNT 208
097
Gradone Lineare Rett. / HNT 208
110
Step / Stufe / Nez de marche
60x60 cm 24x24 in



Gradone Angolare / HNT 210
120
Gradone Angolare Rett. / HNT 210
134
Corner Step / Eckstufe / Nez de marche angulaire
60x60 cm 24x24 in



Gradone Angolare / HNT 205
120
Gradone Angolare Rett. / HNT 205
134
Corner Step / Eckstufe / Nez de marche angulaire
60x60 cm 24x24 in



Gradone Angolare / HNT 208
120
Gradone Angolare Rett. / HNT 208
134
Corner Step / Eckstufe / Nez de marche angulaire
60x60 cm 24x24 in

Bordo naturale o rettificato?
Leggi a pagina 24
Natural or rectified edges?
Read on page 24

Presskante oder rektifizierte Kante?
Bitte siehe Seite 24
Bord naturel ou rectifié?
Voir page 24

Disponibile in composizione modulare (p. 88)
Available in modular pattern (p. 88) • In modularer Zusammensetzung vorraetig (p. 88) • Disponible en pose modulaire (p. 88)





HSU 201
60x60 cm 24x24 in





HSU 201 Rett.
60x60 cm 24x24 in



HSU 208
60x60 cm 24x24 in



HSU 208 Rett.
60x60 cm 24x24 in

HSU 205
60x60 cm 24x24 in



HSU 205 Rett.
60x60 cm 24x24 in

Pezzi Speciali Special Pieces • Formteile • Pièces Spéciales





Gradone Lineare / HSU 201

Gradone Lineare Rett. / HSU 201

Step / Stufe / Nez de marche
60x60 cm 24x24 in





Gradone Lineare / HSU 205

Gradone Lineare Rett. / HSU 205

Step / Stufe / Nez de marche
60x60 cm 24x24 in





Gradone Lineare / HSU 208

Gradone Lineare Rett. / HSU 208

Step / Stufe / Nez de marche
60x60 cm 24x24 in





Gradone Angolare / HSU 201

Gradone Angolare Rett. / HSU 201

Corner Step / Eckstufe / Nez de marche angulaire
60x60 cm 24x24 in



Gradone Angolare / HSU 205

Gradone Angolare Rett. / HSU 205

Corner Step / Eckstufe / Nez de marche angulaire
60x60 cm 24x24 in



Gradone Angolare / HSU 208

Gradone Angolare Rett. / HSU 208

Corner Step / Eckstufe / Nez de marche angulaire
60x60 cm 24x24 in

Bordo naturale o rettificato?
Leggi a pagina 24

Natural or rectified edges?
Read on page 24

Presskante oder rektifizierte Kante?
Bitte siehe Seite 24

Bord naturel ou rectifié?
Voir page 24





HTE 201
60x60 cm 24x24 in
118

HTE 201 Rett.
60x60 cm 24x24 in
131



HTE 205
60x60 cm 24x24 in
118

HTE 205 Rett.
60x60 cm 24x24 in
131



Pezzi Speciali Special Pieces • Formteile • Pièces Spéciales



HDV 205
60x60 cm 24x24 in
118

HDV 205 Rett.
60x60 cm 24x24 in
131



HDV 209
60x60 cm 24x24 in
118

HDV 209 Rett.
60x60 cm 24x24 in
131



Pezzi Speciali Special Pieces • Formteile • Pièces Spéciales



Gradone Lineare / HTE 201
097
Gradone Lineare Rett. / HTE 201
110
Step / Stufe / Nez de marche
60x60 cm 24x24 in

Gradone Angolare/HTE 201
120
Gradone Angolare Rett./HTE 201
134
Corner Step / Eckstufe / Nez de marche angulaire
60x60 cm 24x24 in

Gradone Lineare / HTE 205
097
Gradone Lineare Rett. / HTE 205
110
Step / Stufe / Nez de marche
60x60 cm 24x24 in

Gradone Angolare/HTE 205
120
Gradone Angolare Rett./HTE 205
134
Corner Step / Eckstufe / Nez de marche angulaire
60x60 cm 24x24 in

Gradone Lineare / HDV 205
097
Gradone Lineare Rett. / HDV 205
110
Step / Stufe / Nez de marche
60x60 cm 24x24 in

Gradone Angolare/HDV 205 (DX-R)
120
Gradone Angolare Rett./HDV 205 (DX-R)
Gradone Angolare Rett./HDV 205 (SX-L)
134
Corner Step / Eckstufe / Nez de marche angulaire
60x60 cm 24x24 in

Gradone Lineare / HDV 209
097
Gradone Lineare Rett. / HDV 209
110
Step / Stufe / Nez de marche
60x60 cm 24x24 in

Gradone Angolare/HDV 209 (DX-R)
120
Gradone Angolare Rett./HDV 209 (DX-R)
Gradone Angolare Rett./HDV 209 (SX-L)
134
Corner Step / Eckstufe / Nez de marche angulaire
60x60 cm 24x24 in

Disponibile in composizione modulare (p. 90)
Available in modular pattern (p. 90) • In modularer Zusammensetzung vorraetig (p. 90) • Disponible en pose modulaire (p. 90)

Bordo naturale o rettificato?
Leggi a pagina 24

Natural or rectified edges?
Read on page 24

Presskante oder rektifizierte Kante?
Bitte siehe Seite 24

Bord naturel ou rectifié?
Voir page 24



HSA 205
 40x80 cm 16x32 in
 □127



HSA 201
 40x80 cm 16x32 in
 □127

HSA 205 Rett.
 40x80 cm 16x32 in
 □140

HSA 201 Rett.
 40x80 cm 16x32 in
 □140



HSA 215
 40x80 cm 16x32 in
 □127



HSA 209
 40x80 cm 16x32 in
 □127

HSA 215 Rett.
 40x80 cm 16x32 in
 □140

HSA 209 Rett.
 40x80 cm 16x32 in
 □140

Pezzi Speciali Special Pieces • Formteile • Pièces Spéciales



Gradone Lineare / HSA 205
 □109
Gradone Lineare Rett. / HSA 205
 □120
 Step / Stufe / Nez de marche
 40x80 cm 16x32 in



Gradone Lineare / HSA 215
 □109
Gradone Lineare Rett. / HSA 215
 □120
 Step / Stufe / Nez de marche
 40x80 cm 16x32 in



Gradone Lineare / HSA 201
 □109
Gradone Lineare Rett. / HSA 201
 □120
 Step / Stufe / Nez de marche
 40x80 cm 16x32 in



Gradone Lineare / HSA 209
 □109
Gradone Lineare Rett. / HSA 209
 □120
 Step / Stufe / Nez de marche
 40x80 cm 16x32 in



Gradone Angolare/HSA 205 (DX-R)
Gradone Angolare/HSA 205 (SX-L)
 □097
Gradone Angolare Rett./HSA 205 (DX-R)
Gradone Angolare Rett./HSA 205 (SX-L)
 □104
 Corner Step / Eckstufe / Nez de marche angulaire
 40x40 cm 16x16 in



Gradone Angolare/HSA 215 (DX-R)
Gradone Angolare/HSA 215 (SX-L)
 □097
Gradone Angolare Rett./HSA 215 (DX-R)
Gradone Angolare Rett./HSA 215 (SX-L)
 □104
 Corner Step / Eckstufe / Nez de marche angulaire
 40x40 cm 16x16 in



Gradone Angolare/HSA 201 (DX-R)
Gradone Angolare/HSA 201 (SX-L)
 □097
Gradone Angolare Rett./HSA 201 (DX-R)
Gradone Angolare Rett./HSA 201 (SX-L)
 □104
 Corner Step / Eckstufe / Nez de marche angulaire
 40x40 cm 16x16 in



Gradone Angolare/HSA 209 (DX-R)
Gradone Angolare/HSA 209 (SX-L)
 □097
Gradone Angolare Rett./HSA 209 (DX-R)
Gradone Angolare Rett./HSA 209 (SX-L)
 □104
 Corner Step / Eckstufe / Nez de marche angulaire
 40x40 cm 16x16 in





HEK 201
40x80 cm 16x32 in

HEK 201 Rett.
40x80 cm 16x32 in
 



HEK 205
40x80 cm 16x32 in

HEK 205 Rett.
40x80 cm 16x32 in
 







HEK 211
40x80 cm 16x32 in

HEK 211 Rett.
40x80 cm 16x32 in
 





Bordo naturale o rettificato? Leggi a pagina 24
Natural or rectified edges? Read on page 24
Presskante oder rektifizierte Kante? Bitte siehe Seite 24
Bord naturel ou rectifié? Voir page 24

Pezzi Speciali Special Pieces • Formteile • Pièces Spéciales







Gradone Lineare / HEK 201
 
Gradone Lineare Rett. / HEK 201
 
Step / Stufe / Nez de marche
40x80 cm 16x32 in







Gradone Lineare / HEK 205
 
Gradone Lineare Rett. / HEK 205
 
Step / Stufe / Nez de marche
40x80 cm 16x32 in







Gradone Lineare / HEK 211
 
Gradone Lineare Rett. / HEK 211
 
Step / Stufe / Nez de marche
40x80 cm 16x32 in





Gradone Angolare/HEK 201 (DX-R)
Gradone Angolare/HEK 201 (SX-L)
 
Gradone Angolare Rett./HEK 201 (DX-R)
Gradone Angolare Rett./HEK 201 (SX-L)
 
Corner Step / Eckstufe / Nez de marche angulaire
40x40 cm 16x16 in



Gradone Angolare/HEK 205 (DX-R)
Gradone Angolare/HEK 205 (SX-L)
 
Gradone Angolare Rett./HEK 205 (DX-R)
Gradone Angolare Rett./HEK 205 (SX-L)
 
Corner Step / Eckstufe / Nez de marche angulaire
40x40 cm 16x16 in



Gradone Angolare/HEK 211 (DX-R)
Gradone Angolare/HEK 211 (SX-L)
 
Gradone Angolare Rett./HEK 211 (DX-R)
Gradone Angolare Rett./HEK 211 (SX-L)
 
Corner Step / Eckstufe / Nez de marche angulaire
40x40 cm 16x16 in



Montaggi modulari

Modular pattern installations / Modulare Montagen / Poses modulaires

Cos'è Modular due2?

*What is **Modular due2**? / Was ist **Modular due2**? / Qu'est-ce que **Modular due2**?*

Modular due2 è l'evoluzione del gres porcellanato di 20 mm di spessore, nella produzione del quale Ceramica Del Conca già vanta una delle gamme più complete presenti sul mercato. Questo gres porcellanato è la giusta soluzione per pavimentare ogni tipo di superficie esterna. Resistenza all'usura, allo scivolamento, alle azioni meccaniche e agli agenti atmosferici senza compromessi abbinata ad un valore estetico identico ai più avanzati dei prodotti per interno. Gli articoli della serie **due2** di Ceramica del Conca sono coordinati con articoli di spessore tradizionale per consentire di avere continuità estetica fra l'interno e l'esterno delle abitazioni.

Con **Modular due2** Ceramica del Conca propone prodotti di ultima generazione in formati appositamente pensati per la realizzazione di vari tipi posa modulare. Che siano a bordo naturale o rettificato, questi schemi di posa portano le caratteristiche tecniche della serie **due2** incontro alla richiesta di una estetica nuova ed accattivante, non solo nella grafica e nelle superfici, ma anche nel miscelarsi dei formati. Non di meno, vi aiuta nell'avere tutto quello che vi serve già pronto per la posa; le quantità necessarie di ogni formato sono calcolate e, nel caso dei Modulari Rettificati, fornite già nella giusta proporzione su un unico pallet.

Modular due2 is the evolution of 20 mm thick porcelain stoneware, whose production Ceramica Del Conca already boasts of in one of the most comprehensive ranges on the market. This porcelain stoneware is the right solution for any type of outdoor flooring. Hard wearing, anti-slip, weather-resistant and capable of withstanding heavy loads, without compromises, and with the same aesthetic appeal as the most advanced indoor products. Every item from the **due2** range by Ceramica del Conca is matched with a corresponding item of traditional thickness to match outdoor with indoor décor.

With **Modular due2**, Ceramica del Conca offers next-gen products in formats specially designed to create a variety of modular pattern installations. With both natural or rectified edges, these layouts bear the technical features of the **due2** range, meeting the demand for a new and eye-catching look—not just in its graphics and surfaces, but in the mix of formats as well. Not least, it helps you with all you need ready for installation; the quantities required for each format are calculated and, in the case of Rectified Edge Modular Patterns, already supplied in the right proportions within a single pallet.

Modular due2 ist die Weiterentwicklung des Feinsteinzeugs mit 20 mm Stärke, ein Produktionsbereich, in dem Ceramica Del Conca bereits mit einem der komplettesten Sortimente auf dem Markt vertreten ist. Dieses Feinsteinzeug ist die richtige Lösung für die Fußböden auf allen Flächen im Aussenbereich. Eine kompromisslose Verschleiß- und Rutschfestigkeit, Beständigkeit gegen mechanische Einwirkungen und atmosphärische Einflüsse kombiniert mit dem gleichen ästhetischen Wert wie bei den fortschrittlichsten Produkten für den Innenbereich. Die Artikel der Serie **due2** von Ceramica del Conca sind mit den Artikeln mit traditioneller Stärke koordiniert, damit man eine ästhetische Kontinuität im Innen- und Außenbereich der Wohnungen erzielen kann.

Mit **Modular due2** bietet Ceramica del Conca Produkte der neuesten Generation in Formaten an, die speziell für die Umsetzung verschiedener Arten von modularer Verlegung gedacht sind. Egal, ob die Kanten naturbelassen oder rektifiziert sind, diese Verlegelösungen sorgen dafür, dass die technischen Merkmale der Serie **due2** der Nachfrage nach einer neuen, ansprechenden Ästhetik nicht nur grafisch und oberflächlich, sondern auch durch die Kombinationsmöglichkeit der Formate nachkommen. Ein weiterer wichtiger Pluspunkt: Sie erhalten alle nötigen Materialien verlegungsbereit. Denn die für jedes einzelne Format nötigen Mengen werden berechnet und im Fall der rektifizierten Modularfliesen bereits im richtigen Verhältnis zusammen auf einer Palette geliefert.

Modular due2 est l'évolution du grès cérame de 20 mm d'épaisseur, dans lequel Ceramica Del Conca peut se vanter d'une des gammes les plus complètes présentes sur le marché. Ce grès cérame est la solution idéale pour carreler tout type de surface externe. Résistance à l'usure, au glissement, aux actions mécaniques et aux agents atmosphériques sans compromis associée à une valeur esthétique identique aux produits pour intérieur les plus avancés. Les articles de la série **due2** de Ceramica del Conca sont coordonnés avec des articles d'épaisseur classique afin d'obtenir une continuité esthétique entre l'intérieur et l'extérieur des habitations.

Avec **Modular due2** Ceramica del Conca propose des produits de dernière génération dans des formats spécialement conçus pour la réalisation de différents types de pose modulaire. Qu'ils soient à bord naturel ou rectifié, ces schémas de pose portent les caractéristiques techniques de la série **due2** face à la demande d'un nouveau design attrayant, non seulement dans les décorations et les surfaces, mais aussi dans le mélange des formats. Elle vous permet, en plus, de disposer de tout le nécessaire déjà prêt pour la pose; les quantités nécessaires dans chaque format sont calculées et, dans le cas des Modulars rectifiés, déjà fournies dans la bonne proportion sur une seule palette.

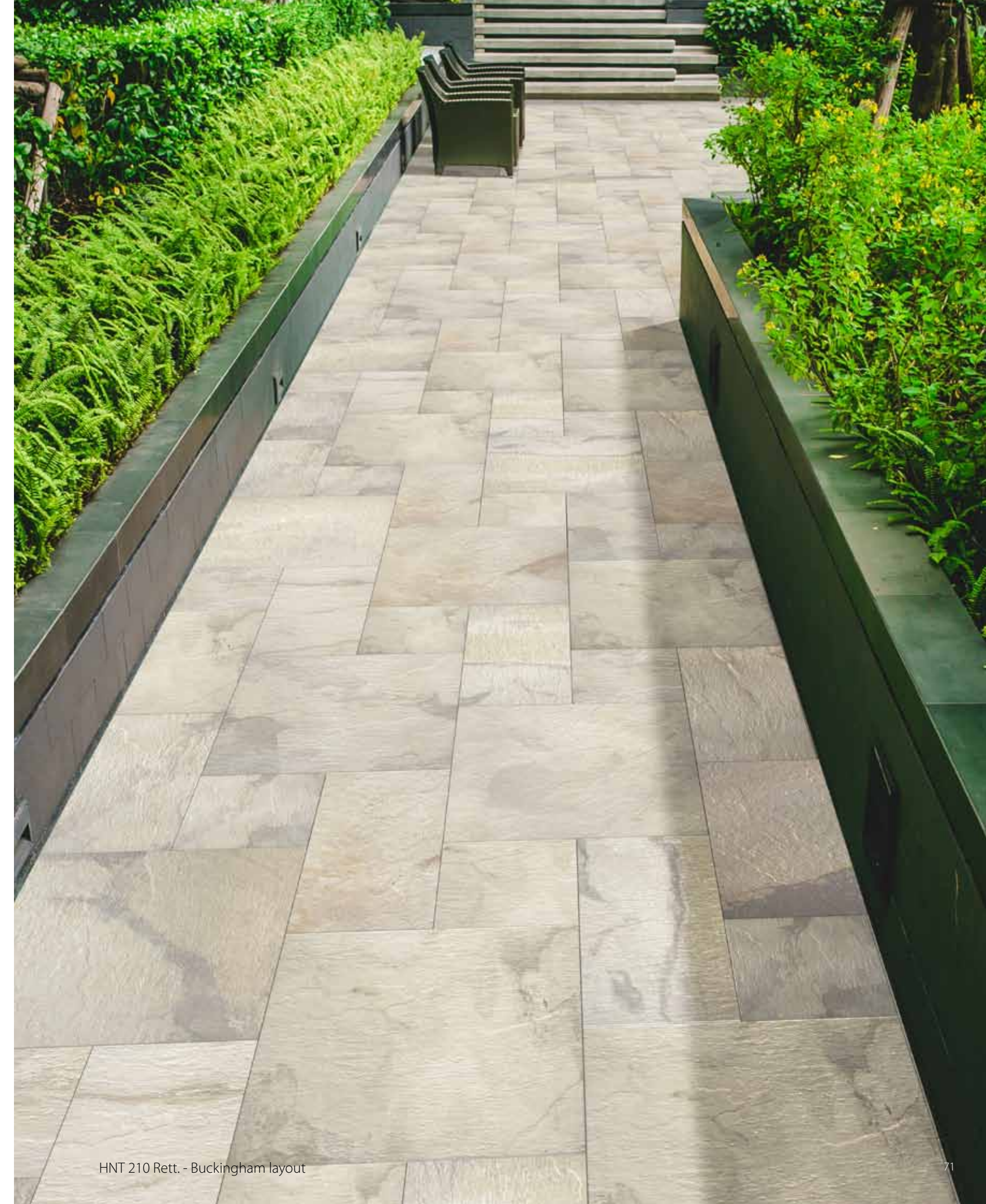



Modulari pressati

Pressed edges modular patterns
Gepresste Modularfliesen
Modulaires pressés

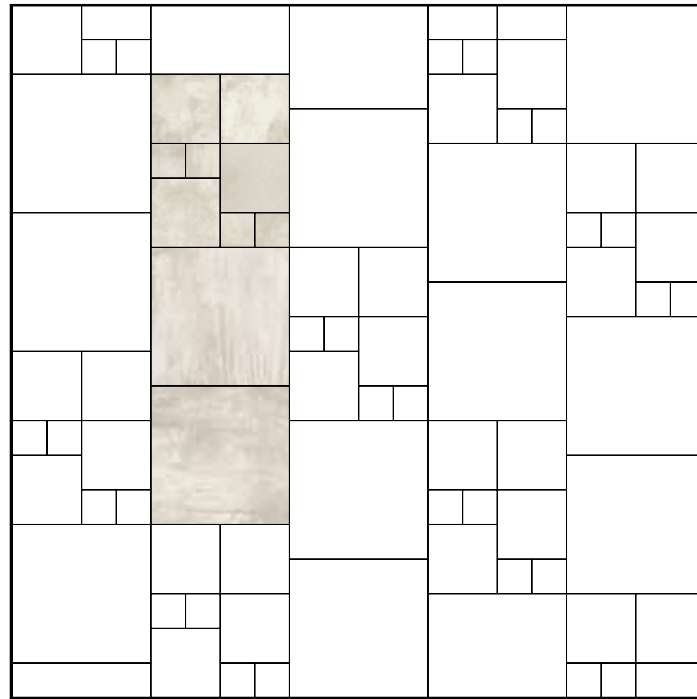

| Formats | % | pieces/m ² |
|--------------|--------|-----------------------|
| 80x80 | 61,54% | 0,96 |
| 40x40 | 30,77% | 1,92 |
| 20x20 | 7,69% | 1,92 |

| Package | 80x80 | 40x40 | 20x20 | |
|------------|---------------|--------|---------|---------|
| Box | Pieces | 1 | 3 | 13 |
| | Mq. | 0,64 | 0,48 | 0,52 |
| | Kg. | 30,00 | 23,04 | 24,96 |
| Europallet | Boxes | 26 | 48 | 45 |
| | Mq. | 16,64 | 23,04 | 23,40 |
| | Kg. | 795,00 | 1126,00 | 1144,00 |

Disponibile per la serie

Available on ranges • Vorraetig bei den Serien • Disponibles pour les séries

UPGRADE ²



HUP 210 - HUP 205
HUP 215 - HUP 209

La serie HUP è disponibile in formati adatti ad un montaggio modulare. I diversi formati, prodotti da pressa e con bordi naturali, sono pallettizzati singolarmente e devono essere ordinati separatamente secondo le quantità riportate in tabella. Previa comunicazione, l'ufficio commerciale provvederà a fornire toni e calibri compatibili.

The HUP range is available in formats for installation in a modular pattern. The various formats, products with pressed and natural edges, are individually palletised and must be ordered separately according to the quantities given in the table. Subject to notification, the customer service will provide compatible shades and calibers.

Die Serie HUP ist in Formaten erhältlich, die sich für eine modulare Verlegung eignen. Die verschiedenen gepressten und mit naturbelassenen Kanten erzeugten Formate werden einzeln palettiert und müssen separat entsprechend den in der Tabelle angeführten Mengen bestellt werden. Auf Anfrage wird Ihnen die Verkaufsabteilung die kompatiblen Farbtöne und Kaliber liefern.

La série HUP est disponible dans des formats adaptés à un montage modulaire. Les différents formats, fabriqués par presse et avec bords naturels, sont palettisés individuellement et doivent être commandés séparément en fonction des quantités indiquées dans le tableau. Après communication, le bureau commercial fournira des tons et des calibres compatibles.

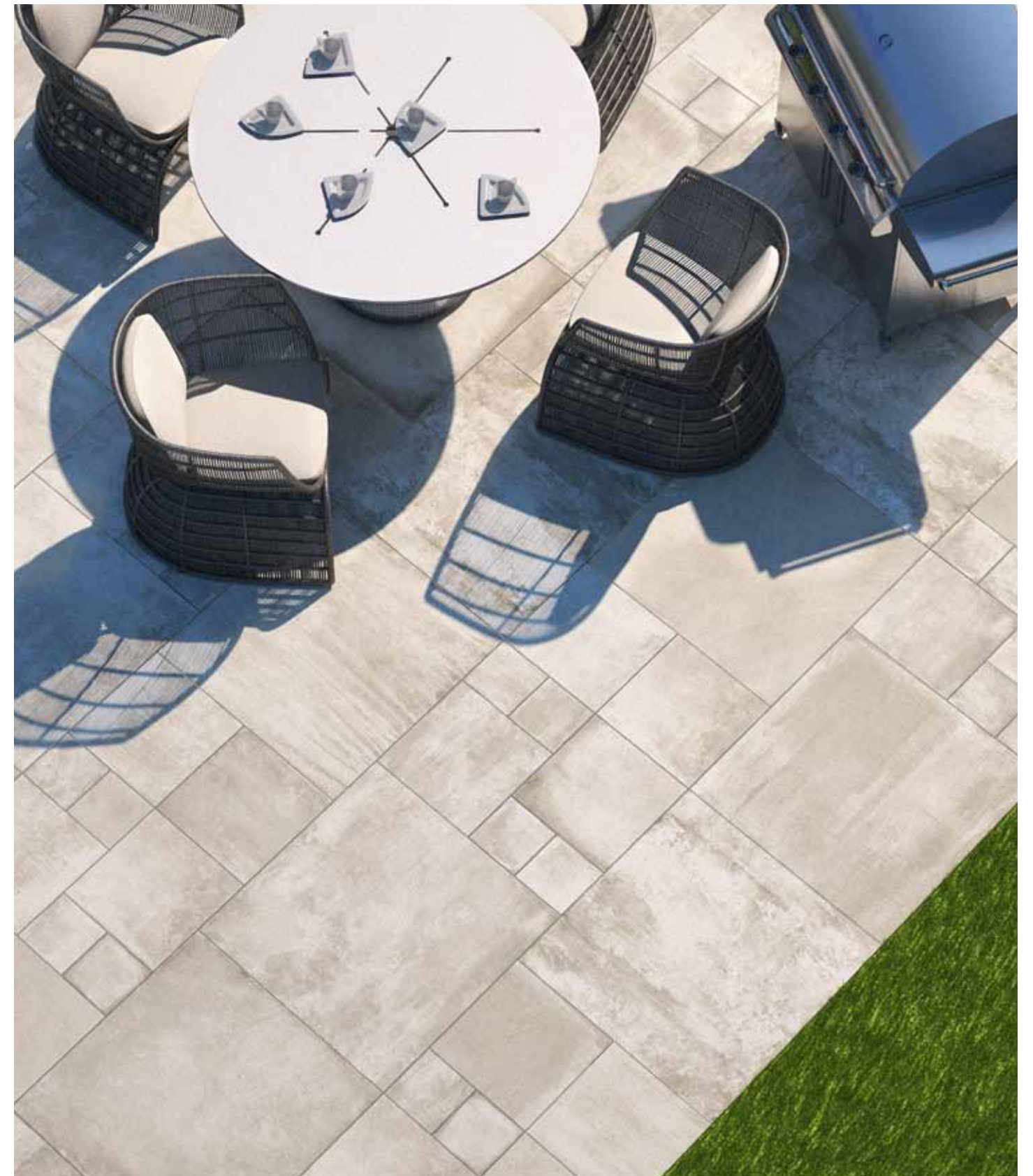

HUP 210 80x80 cm - 40x40 cm - 20x20 cm 32x32 in - 16x16 in - 8x8 in



HUP 210
80x80 cm 32x32 in
□154

HUP 210 Rett.
80x80 cm 32x32 in
□171



HUP 205
80x80 cm 32x32 in
□154

HUP 205 Rett.
80x80 cm 32x32 in
□171



HUP 215
80x80 cm 32x32 in
□154

HUP 215 Rett.
80x80 cm 32x32 in
□171



HUP 209
80x80 cm 32x32 in
□154

HUP 209 Rett.
80x80 cm 32x32 in
□171



HUP 210
40x40 cm 16x16 in
□118



HUP 210
20x20 cm 8x8 in
□118



HUP 205
40x40 cm 16x16 in
□118



HUP 205
20x20 cm 8x8 in
□118



HUP 215
40x40 cm 16x16 in
□118



HUP 215
20x20 cm 8x8 in
□118



HUP 209
40x40 cm 16x16 in
□118



HUP 209
20x20 cm 8x8 in
□118

Pezzi Speciali Special Pieces • Formteile • Pièces Spéciales



Gradone Lineare / HUP 210
□227
Gradone Lineare Rett. / HUP 210
□247
Step / Stufe / Nez de marche
80x80 cm 32x32 in



Gradone Lineare / HUP 210
□055
Step / Stufe / Nez de marche
40x40 cm 16x16 in



Gradone Lineare / HUP 205
□227
Gradone Lineare Rett. / HUP 205
□247
Step / Stufe / Nez de marche
80x80 32"x32"



Gradone Lineare / HUP 205
□055
Step / Stufe / Nez de marche
40x40 cm 16x16 in



Gradone Lineare / HUP 215
□227
Gradone Lineare Rett. / HUP 215
□247
Step / Stufe / Nez de marche
80x80 cm 32x32 in



Gradone Lineare / HUP 215
□055
Step / Stufe / Nez de marche
40x40 cm 16x16 in



Gradone Lineare / HUP 209
□227
Gradone Lineare Rett. / HUP 209
□247
Step / Stufe / Nez de marche
80x80 cm 32x32 in



Gradone Lineare / HUP 209
□055
Step / Stufe / Nez de marche
40x40 cm 16x16 in



Gradone Angolare / HUP 210
□317
Gradone Angolare Rett. / HUP 210
□317
Corner Step / Eckstufe / Nez de marche angulaire
80x80 cm 32x32 in



Gradone Angolare / HUP 210
□097
Step / Stufe / Nez de marche
40x40 cm 16x16 in



Gradone Angolare / HUP 205
□317
Gradone Angolare Rett. / HUP 205
□317
Corner Step / Eckstufe / Nez de marche angulaire
80x80 32"x32"



Gradone Angolare / HUP 205
□097
Step / Stufe / Nez de marche
40x40 cm 16x16 in



Gradone Angolare / HUP 215
□317
Gradone Angolare Rett. / HUP 215
□317
Corner Step / Eckstufe / Nez de marche angulaire
80x80 cm 32x32 in



Gradone Angolare / HUP 215
□097
Step / Stufe / Nez de marche
40x40 cm 16x16 in



Gradone Angolare / HUP 209
□317
Gradone Angolare Rett. / HUP 209
□317
Corner Step / Eckstufe / Nez de marche angulaire
80x80 cm 32x32 in



Gradone Angolare / HUP 209
□097
Step / Stufe / Nez de marche
40x40 cm 16x16 in

Modulari rettificati

*Rectified edges modular patterns
Rektifizierte Modularfliesen
Modulaires rectifiés*

Schema di posa **Versailles**

VERSAILLES layout / VERSAILLES Verlegelösungen / Plan de pose VERSAILLES

Schema di posa **Eliseo**

ELISEO layout / ELISEO Verlegelösungen / Plan de pose ELISEO

Schema di posa **Buckingham**

BUCKINGHAM layout / BUCKINGHAM Verlegelösungen / Plan de pose BUCKINGHAM

Schema di posa Versailles

VERSAILLES layout / VERSAILLES Verlegeloesungen / Plan de pose VERSAILLES

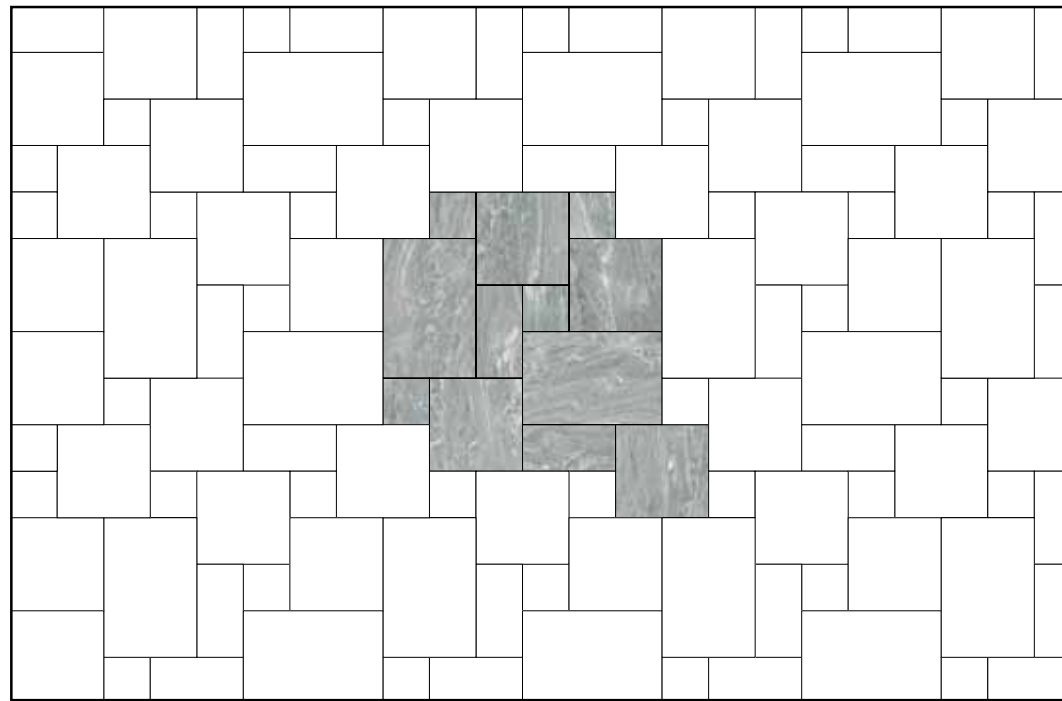

| Formats | % | m ² /pallet | pc/pallet |
|---------------------|--------|------------------------|-----------|
| 30x30 | 11,10% | 1,80 | 20 |
| 30x60 | 11,10% | 1,80 | 10 |
| 60x60 | 44,40% | 7,20 | 20 |
| 60x90 | 33,40% | 5,40 | 10 |
| Total/Pallet | 100% | 16,20 | 60 |



186

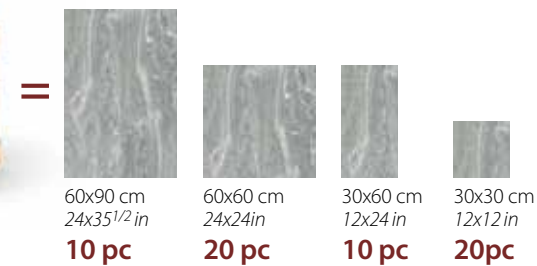

HEG 208 Rett.

Disponibile per la serie Available on ranges • Vorraetig bei den Serien • Disponibles pour les séries



HEG 205
HEG 208

Questi articoli sono forniti già pronti per un montaggio modulare. Ogni schema di posa è disponibile su alcune serie di prodotti, che vengono forniti rettificati e già su un unico pallet secondo le quantità necessarie, come da tabella.

Gli articoli sono ordinabili solo a pallet completi.

These items are supplied ready for installation in a modular pattern. Each layout is available on some product ranges, supplied rectified and already within a single pallet according to the quantities required, as per the table.

The items can be ordered only in complete pallets.

Diese Artikel werden bereits für eine modulare Montage bereit geliefert. Jede Verlegelösung ist für einige Produktserien erhältlich, die rektifiziert und in den notwendigen Mengen entsprechend der Tabelle zusammen auf einer Palette geliefert.

Diese Artikel können nur in ganzen Paletten bestellt werden.

Ces articles sont fournis déjà prêts pour un montage modulaire. Chaque schéma de pose est disponible sur certaines séries de produits, qui sont fournis rectifiés et déjà sur une seule palette en fonction des quantités nécessaires, comme dans le tableau.

Les articles peuvent être commandés uniquement par palettes complètes.

Pezzi Speciali Special Pieces • Formteile • Pièces Spéciales



Gradone Lineare / HEG 205

109

Gradone Lineare Rett. / HEG 205

120

Step / Stufe / Nez de marche

40x80 cm 16x32 in



Gradone Angolare/HEG 205 (DX-R)

097

Gradone Angolare Rett./HEG 205 (DX-R)

104

Corner Step / Eckstufe / Nez de marche angulaire

40x40 cm 16x16 in



Gradone Lineare / HEG 205

268

Gradone Lineare Rett. / HEG 205

293

Step / Stufe / Nez de marche

60x120 cm 24x48 in



Gradone Lineare / HEG 208

109

Gradone Lineare Rett. / HEG 208

120

Step / Stufe / Nez de marche

40x80 cm 16x32 in



Gradone Angolare/HEG 208 (DX-R)

097

Gradone Angolare Rett./HEG 208 (DX-R)

104

Corner Step / Eckstufe / Nez de marche angulaire

40x40 cm 16x16 in



Gradone Lineare / HEG 208

268

Gradone Lineare Rett. / HEG 208

293

Step / Stufe / Nez de marche

60x120 cm 24x48 in

Schema di posa Eliseo

ELISEO layout / ELISEO Verlegeloesungen / Plan de pose ELISEO

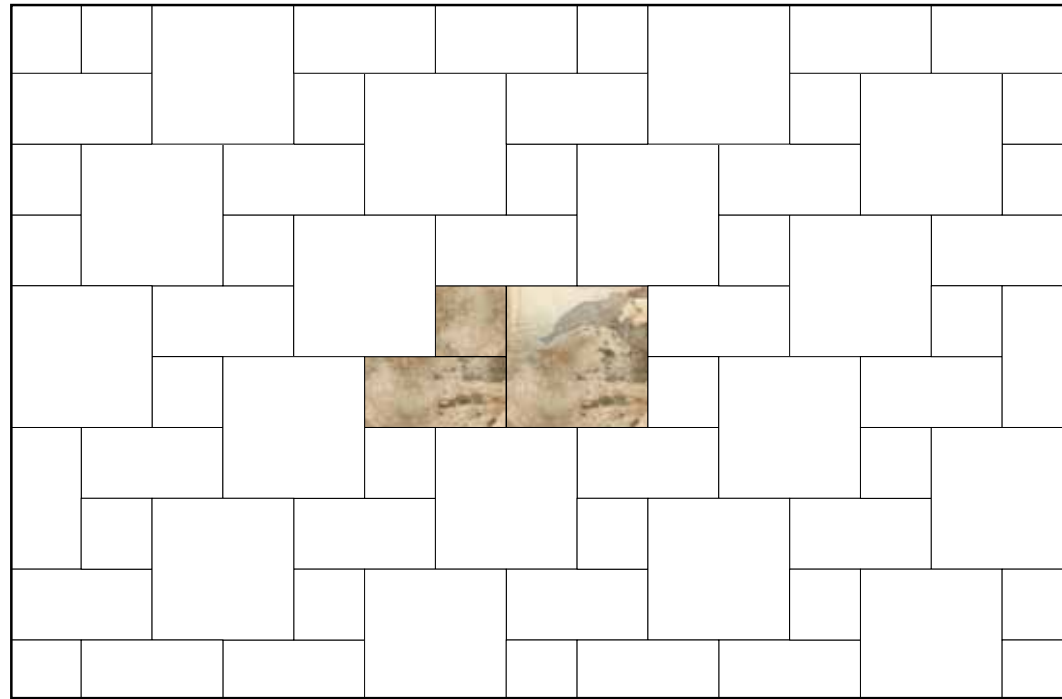

| Formats | % | m ² /pallet | pc/pallet |
|---------------------|--------|------------------------|-----------|
| 40x40 | 14,85% | 2,40 | 15 |
| 40x80 | 29,70% | 4,80 | 15 |
| 80x80 | 55,45% | 8,96 | 14 |
| Total/Pallet | 100% | 16,16 | 44 |



186

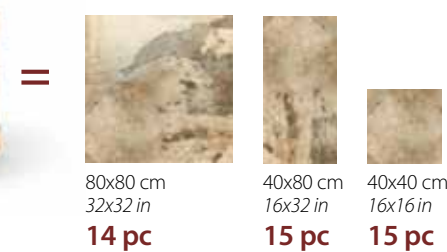

80x80 cm
32x32 in

14 pc

40x80 cm
16x32 in

15 pc

40x40 cm
16x16 in

15 pc



HED 211 Rett.

Disponibile per la serie Available on ranges • Vorraetig bei den Serien • Disponibles pour les séries

ElDorado² CLIMB² BLUE PEPPER²



HED 211

HCL 210
HCL 205
HCL 209
HCL 208

HBP 205
HBP 208

Questi articoli sono forniti già pronti per un montaggio modulare. Ogni schema di posa è disponibile su alcune serie di prodotti, che vengono forniti rettificati e già su un unico pallet secondo le quantità necessarie, come da tabella.

Gli articoli sono ordinabili solo a pallet completi.

These items are supplied ready for installation in a modular pattern. Each layout is available on some product ranges, supplied rectified and already within a single pallet according to the quantities required, as per the table.

The items can be ordered only in complete pallets.

Diese Artikel werden bereits für eine modulare Montage bereit geliefert. Jede Verlegelösung ist für einige Produktserien erhältlich, die rektifiziert und in den notwendigen Mengen entsprechend der Tabelle zusammen auf einer Palette geliefert.

Diese Artikel können nur in ganzen Paletten bestellt werden.

Ces articles sont fournis déjà prêts pour un montage modulaire. Chaque schéma de pose est disponible sur certaines séries de produits, qui sont fournis rectifiés et déjà sur une seule palette en fonction des quantités nécessaires, comme dans le tableau.

Les articles peuvent être commandés uniquement par palettes complètes.

Pezzi Speciali Special Pieces • Formteile • Pièces Spéciales



Gradone Lineare / HED 211
227
Gradone Lineare Rett. / HED 211
247
Step / Stufe / Nez de marche
80x80 cm 32x32 in

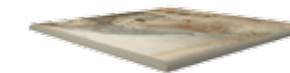

Gradone Angolare / HED 211
317
Gradone Angolare Rett. / HED 211
317
Corner Step / Eckstufe / Nez de marche angulaire
80x80 cm 32x32 in

Schema di posa Eliseo

ELISEO layout / ELISEO Verlegeloesungen / Plan de pose ELISEO

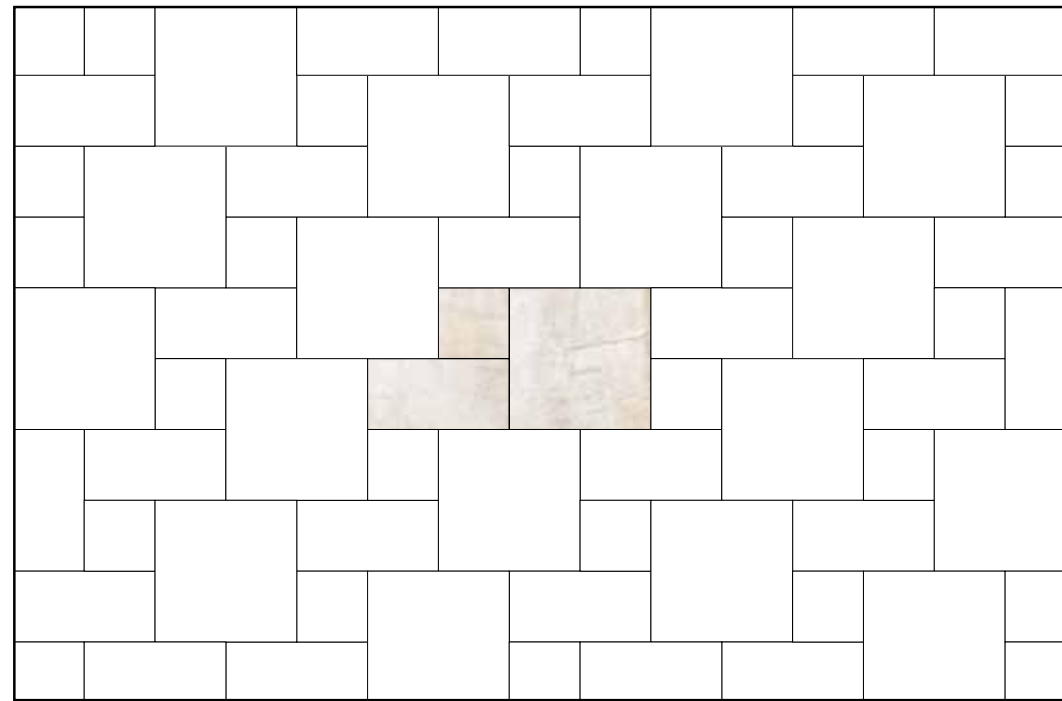

| Formats | % | m ² /pallet | pc/pallet |
|---------------------|--------|------------------------|-----------|
| 40x40 | 14,85% | 2,40 | 15 |
| 40x80 | 29,70% | 4,80 | 15 |
| 80x80 | 55,45% | 8,96 | 14 |
| Total/Pallet | 100% | 16,16 | 44 |



186

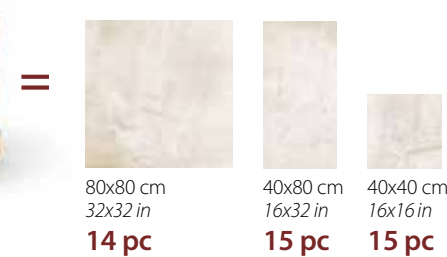

HCL 205 Rett.

Disponibile per la serie Available on ranges • Vorraetig bei den Serien • Disponibles pour les séries

ElDorado² CLIMB² BLUE PEPPER²



HED 211
HCL 210
HCL 205
HCL 209
HCL 208

HBP 205
HBP 208

Questi articoli sono forniti già pronti per un montaggio modulare. Ogni schema di posa è disponibile su alcune serie di prodotti, che vengono forniti rettificati e già su un unico pallet secondo le quantità necessarie, come da tabella.

Gli articoli sono ordinabili solo a pallet completi.

These items are supplied ready for installation in a modular pattern. Each layout is available on some product ranges, supplied rectified and already within a single pallet according to the quantities required, as per the table.

The items can be ordered only in complete pallets.

Diese Artikel werden bereits für eine modulare Montage bereit geliefert. Jede Verlegelösung ist für einige Produktserien erhältlich, die rektifiziert und in den notwendigen Mengen entsprechend der Tabelle zusammen auf einer Palette geliefert.

Diese Artikel können nur in ganzen Paletten bestellt werden.

Ces articles sont fournis déjà prêts pour un montage modulaire. Chaque schéma de pose est disponible sur certaines séries de produits, qui sont fournis rectifiés et déjà sur une seule palette en fonction des quantités nécessaires, comme dans le tableau.

Les articles peuvent être commandés uniquement par palettes complètes.

Pezzi Speciali Special Pieces • Formteile • Pièces Spéciales



Gradone Lineare / HCL 210

227
Gradone Lineare Rett. / HCL 210

247
Step / Stufe / Nez de marche
80x80 cm 32x32 in

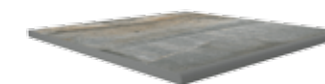

Gradone Lineare / HCL 205

227
Gradone Lineare Rett. / HCL 205

247
Step / Stufe / Nez de marche
80x80 cm 32x32 in



Gradone Lineare / HCL 209

227
Gradone Lineare Rett. / HCL 209

247
Step / Stufe / Nez de marche
80x80 cm 32x32 in

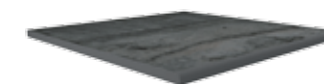

Gradone Lineare / HCL 208

227
Gradone Lineare Rett. / HCL 208

247
Step / Stufe / Nez de marche
80x80 cm 32x32 in



Gradone Angolare / HCL 210

317
Gradone Angolare Rett. / HCL 210

317
Corner Step / Eckstufe / Nez de marche
angulaire
80x80 cm 32x32 in

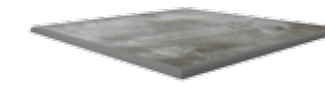

Gradone Angolare / HCL 205

317
Gradone Angolare Rett. / HCL 205

317
Corner Step / Eckstufe / Nez de marche
angulaire
80x80 cm 32x32 in



Gradone Angolare / HCL 209

317
Gradone Angolare Rett. / HCL 209

317
Corner Step / Eckstufe / Nez de marche
angulaire
80x80 cm 32x32 in

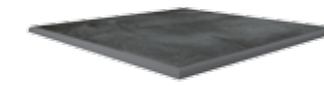

Gradone Angolare / HCL 208

317
Gradone Angolare Rett. / HCL 208

317
Corner Step / Eckstufe / Nez de marche
angulaire
80x80 cm 32x32 in

Schema di posa Eliseo

ELISEO layout / ELISEO Verlegeloesungen / Plan de pose ELISEO

BLUE PEPPER²

20mm due 2

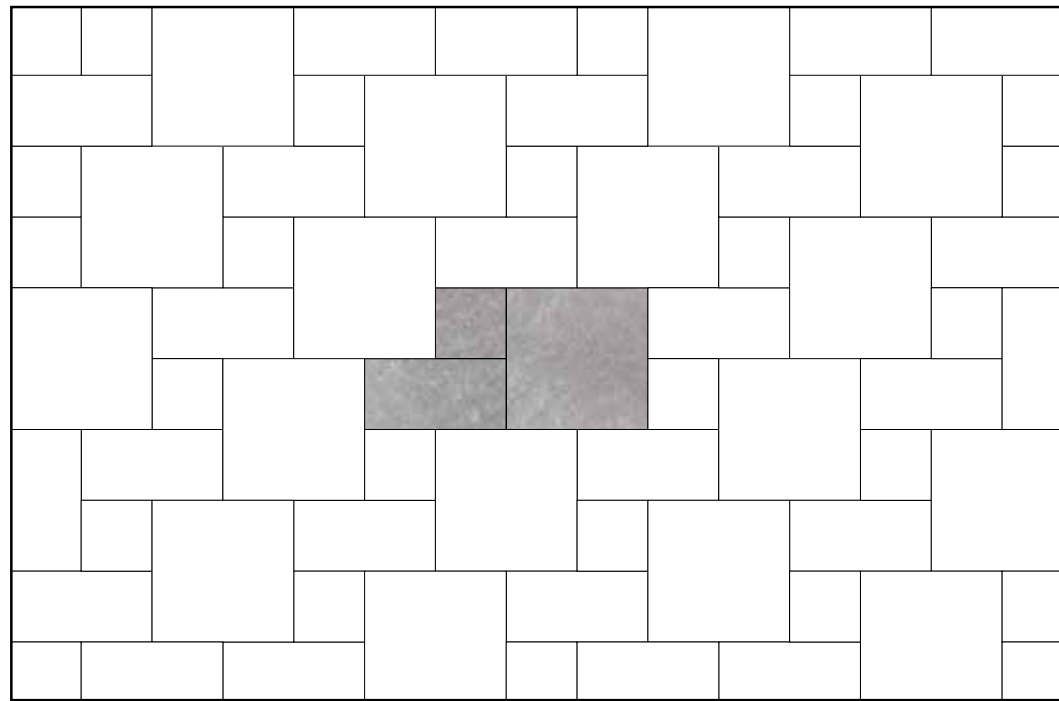

| Formats | % | m ² /pallet | pc/pallet |
|---------------------|--------|------------------------|-----------|
| 40x40 | 14,85% | 2,40 | 15 |
| 40x80 | 29,70% | 4,80 | 15 |
| 80x80 | 55,45% | 8,96 | 14 |
| Total/Pallet | 100% | 16,16 | 44 |



186

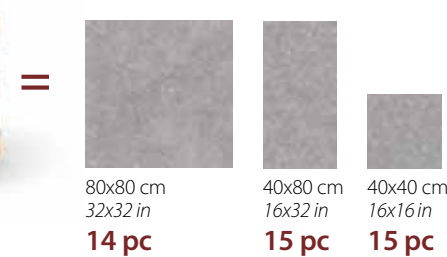

HBP 208 Rett.

Disponibile per la serie Available on ranges • Vorraetig bei den Serien • Disponibles pour les séries

ElDorado² CLIMB² BLUE PEPPER²



HED 211

HCL 210
HCL 205
HCL 209
HCL 208

HBP 205
HBP 208

Questi articoli sono forniti già pronti per un montaggio modulare. Ogni schema di posa è disponibile su alcune serie di prodotti, che vengono forniti rettificati e già su un unico pallet secondo le quantità necessarie, come da tabella.

Gli articoli sono ordinabili solo a pallet completi.

These items are supplied ready for installation in a modular pattern. Each layout is available on some product ranges, supplied rectified and already within a single pallet according to the quantities required, as per the table.

The items can be ordered only in complete pallets.

Diese Artikel werden bereits für eine modulare Montage bereit geliefert. Jede Verlegelösung ist für einige Produktserien erhältlich, die rektifiziert und in den notwendigen Mengen entsprechend der Tabelle zusammen auf einer Palette geliefert.

Diese Artikel können nur in ganzen Paletten bestellt werden.

Ces articles sont fournis déjà prêts pour un montage modulaire. Chaque schéma de pose est disponible sur certaines séries de produits, qui sont fournis rectifiés et déjà sur une seule palette en fonction des quantités nécessaires, comme dans le tableau.

Les articles peuvent être commandés uniquement par palettes complètes.

Pezzi Speciali Special Pieces • Formteile • Pièces Spéciales

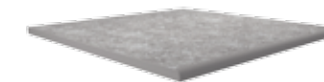

Gradone Lineare / HBP 205

227

Gradone Lineare Rett. / HBP 205

247

Step / Stufe / Nez de marche
80x80 cm 32x32 in

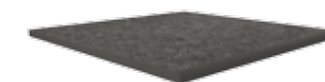

Gradone Lineare / HBP 208

227

Gradone Lineare Rett. / HBP 208

247

Step / Stufe / Nez de marche
80x80 cm 32x32 in

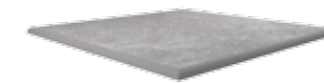

Gradone Angolare / HBP 205

317

Gradone Angolare Rett. / HBP 205

317

Corner Step / Eckstufe / Nez de marche
angulaire
80x80 cm 32x32 in

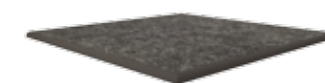

Gradone Angolare / HBP 208

317

Gradone Angolare Rett. / HBP 208

317

Corner Step / Eckstufe / Nez de marche
angulaire
80x80 cm 32x32 in

Schema di posa Buckingham

BUCKINGHAM layout / BUCKINGHAM Verlegeloesungen / Plan de pose BUCKINGHAM

NAT²

20mm due 2

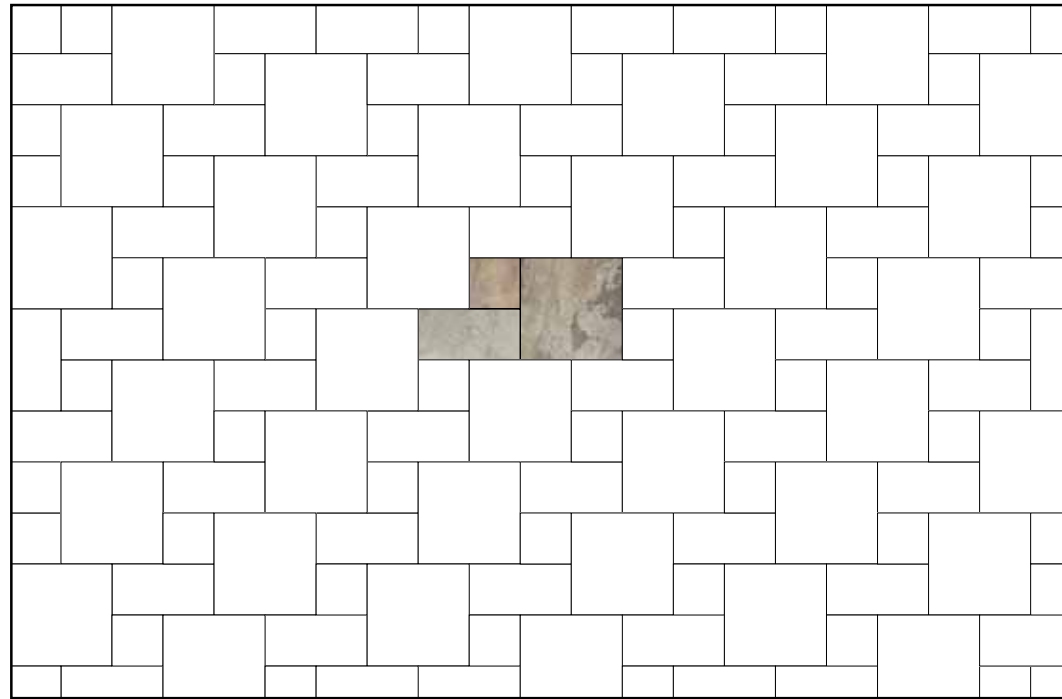

| Formats | % | m ² /pallet | pc/pallet |
|---------------------|--------|------------------------|-----------|
| 30x30 | 14,85% | 2,70 | 30 |
| 30x60 | 29,70% | 5,40 | 30 |
| 60x60 | 55,45% | 10,08 | 28 |
| Total/Pallet | 100% | 18,18 | 88 |



151



HNT 210 Rett.

Disponibile per la serie Available on ranges • Vorraetig bei den Serien • Disponibles pour les séries

Pezzi Speciali Special Pieces • Formteile • Pièces Spéciales

NAT²

TREVI²



HNT 210
HNT 205
HNT 208



HTE 201
HTE 205

Questi articoli sono forniti già pronti per un montaggio modulare. Ogni schema di posa è disponibile su alcune serie di prodotti, che vengono forniti rettificati e già su un unico pallet secondo le quantità necessarie, come da tabella.

Gli articoli sono ordinabili solo a pallet completi.

These items are supplied ready for installation in a modular pattern. Each layout is available on some product ranges, supplied rectified and already within a single pallet according to the quantities required, as per the table.

The items can be ordered only in complete pallets.

Diese Artikel werden bereits für eine modulare Montage bereit geliefert. Jede Verlegelösung ist für einige Produktserien erhältlich, die rektifiziert und in den notwendigen Mengen entsprechend der Tabelle zusammen auf einer Palette geliefert.

Diese Artikel können nur in ganzen Paletten bestellt werden.

Ces articles sont fournis déjà prêts pour un montage modulaire. Chaque schéma de pose est disponible sur certaines séries de produits, qui sont fournis rectifiés et déjà sur une seule palette en fonction des quantités nécessaires, comme dans le tableau.

Les articles peuvent être commandés uniquement par palettes complètes.



Gradone Lineare / HNT 210

097
Gradone Lineare Rett. / HNT 210

110
Step / Stufe / Nez de marche

60x60 cm 24x24 in



Gradone Lineare / HNT 205

097
Gradone Lineare Rett. / HNT 205

110
Step / Stufe / Nez de marche

60x60 cm 24x24 in



Gradone Lineare / HNT 208

097
Gradone Lineare Rett. / HNT 208

110
Step / Stufe / Nez de marche

60x60 cm 24x24 in



Gradone Angolare / HNT 210

120
Gradone Angolare Rett. / HNT 210

134
Corner Step / Eckstufe / Nez de marche angulaire

60x60 cm 24x24 in



Gradone Angolare / HNT 205

120
Gradone Angolare Rett. / HNT 205

134
Corner Step / Eckstufe / Nez de marche angulaire

60x60 cm 24x24 in



Gradone Angolare / HNT 208

120
Gradone Angolare Rett. / HNT 208

134
Corner Step / Eckstufe / Nez de marche angulaire

60x60 cm 24x24 in

Schema di posa Buckingham

BUCKINGHAM layout / BUCKINGHAM Verlegeloesungen / Plan de pose BUCKINGHAM

TREVI²

20mm due²

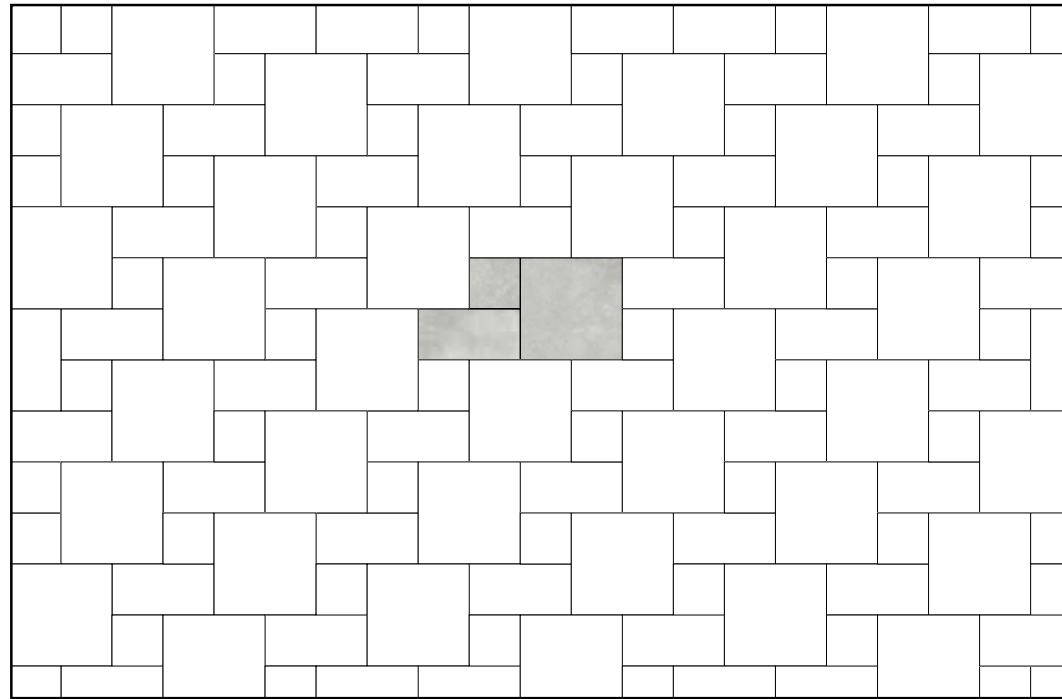

| Formats | % | m ² /pallet | pc/pallet |
|---------------------|--------|------------------------|-----------|
| 30x30 | 14,85% | 2,70 | 30 |
| 30x60 | 29,70% | 5,40 | 30 |
| 60x60 | 55,45% | 10,08 | 28 |
| Total/Pallet | 100% | 18,18 | 88 |



151

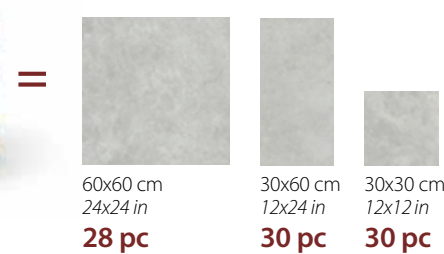

HTE 201 Rett.

Disponibile per la serie Available on ranges • Vorraetig bei den Serien • Disponibles pour les séries

NAT²

TREVI²



HNT 210
HNT 205
HNT 208



HTE 201
HTE 205

Questi articoli sono forniti già pronti per un montaggio modulare. Ogni schema di posa è disponibile su alcune serie di prodotti, che vengono forniti rettificati e già su un unico pallet secondo le quantità necessarie, come da tabella.

Gli articoli sono ordinabili solo a pallet completi.

These items are supplied ready for installation in a modular pattern. Each layout is available on some product ranges, supplied rectified and already within a single pallet according to the quantities required, as per the table.

The items can be ordered only in complete pallets.

Diese Artikel werden bereits für eine modulare Montage bereit geliefert. Jede Verlegelösung ist für einige Produktserien erhältlich, die rektifiziert und in den notwendigen Mengen entsprechend der Tabelle zusammen auf einer Palette geliefert.

Diese Artikel können nur in ganzen Paletten bestellt werden.

Ces articles sont fournis déjà prêts pour un montage modulaire. Chaque schéma de pose est disponible sur certaines séries de produits, qui sont fournis rectifiés et déjà sur une seule palette en fonction des quantités nécessaires, comme dans le tableau.

Les articles peuvent être commandés uniquement par palettes complètes.

Pezzi Speciali Special Pieces • Formteile • Pièces Spéciales



Gradone Lineare / HTE 201
097
Gradone Lineare Rett. / HTE 201
110
Step / Stufe / Nez de marche
60x60 cm 24x24 in



Gradone Lineare / HTE 205
097
Gradone Lineare Rett. / HTE 205
110
Step / Stufe / Nez de marche
60x60 cm 24x24 in



Gradone Angolare/HTE 201
120
Gradone Angolare Rett./HTE 201
134
Corner Step / Eckstufe / Nez de marche angulaire
60x60 cm 24x24 in



Gradone Angolare/HTE 205
120
Gradone Angolare Rett./HTE 205
134
Corner Step / Eckstufe / Nez de marche angulaire
60x60 cm 24x24 in

Mezzaluna Rett. Lato 15
 Crescent Rett. Side 15
 Halbmond Rett. Seite 15
 Bordure demi-lune Rett. Côté 15

Gradone Angolare
 Corner Step
 Eckstufe
 Nez de marche angulaire

Gradone Lineare
 Step
 Stufe
 Nez de marche

Angolo Griglia Rett.
 Corner Grating Rett.
 Gitterecke Rett.
 Angle Caniveau Rett.

Bordo Rett.
 Edge Rett.
 Rand Rett.
 Bord Rett.

Elemento a L Rett.
 L-Shaped Trim Rett.
 L-Element Rett.
 Élément « L » Rett.

Griglia Rett.
 Grating Rett.
 Gitter Rett.
 Caniveau Rett.

Bordo di Aggrappaggio
 (pezzo speciale personalizzato, disponibile su richiesta)
 Cling trim (special personalized part, available upon request)
 Anschmiegekante (Besonderer Teil, nur auf Anfrage produzierbar)
 Bord d'accrochage (pièce spéciale personnalisée, disponible sur demande)

Pezzi Speciali

Special Pieces / Formteile / Pièces Spéciales

Pezzi Speciali

Special Pieces / Formteile / Pièces Spéciales

20mm due 2



Gradone Lineare
Step / Stufe / Nez de marche
40x40 cm 16x16 in
0055



Gradone Lineare
Step / Stufe / Nez de marche
40x80 cm 16x32 in
0109



Gradone Lineare
Step / Stufe / Nez de marche
40x120 cm 16x48 in
0207



Gradone Lineare
Step / Stufe / Nez de marche
80x80 cm 32x32 in
0227



Gradone Lineare
Step / Stufe / Nez de marche
30x60 cm 12x24 in
0077



Gradone Lineare
Step / Stufe / Nez de marche
60x60 cm 24x24 in
0097

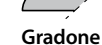

Gradone Lineare
Step / Stufe / Nez de marche
60x90 cm 24x36 in
0163



Gradone Lineare
Step / Stufe / Nez de marche
60x120 cm 24x48 in
0268



Gradone Lineare Rett.
Step / Stufe / Nez de marche
40x80 cm 16x32 in
0120



Gradone Lineare Rett.
Step / Stufe / Nez de marche
40x120 cm 16x48 in
0221



Gradone Lineare Rett.
Step / Stufe / Nez de marche
80x80 cm 32x32 in
0247



Gradone Lineare Rett.
Step / Stufe / Nez de marche
30x60 cm 12x24 in
0083



Gradone Lineare Rett.
Step / Stufe / Nez de marche
60x60 cm 24x24 in
0110



Gradone Lineare Rett.
Step / Stufe / Nez de marche
60x90 cm 24x36 in
0175



Gradone Lineare Rett.
Step / Stufe / Nez de marche
60x120 cm 24x48 in
0293



Gradone Angolare (DX-R)
Gradone Angolare (SX-L)
Corner Step / Eckstufe / Nez de marche angulaire
30x30 cm 12x12 in
0069



Gradone Angolare (DX-R)
Gradone Angolare (SX-L)
Corner Step / Eckstufe / Nez de marche angulaire
40x40 cm 16x16 in
0097



Gradone Angolare (DX-R)
Gradone Angolare (SX-L)
Corner Step / Eckstufe / Nez de marche angulaire
60x60 cm 24x24 in
0120 HQZ-HBO: 0203



Gradone Angolare (DX-R)
Gradone Angolare (SX-L)
Corner Step / Eckstufe / Nez de marche angulaire
80x80 cm 32x32 in
0317

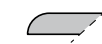

Gradone Angolare Rett. (DX-R)
Gradone Angolare Rett. (SX-L)
Corner Step / Eckstufe / Nez de marche angulaire
30x30 cm 12x12 in
0075



Gradone Angolare Rett. (DX-R)
Gradone Angolare Rett. (SX-L)
Corner Step / Eckstufe / Nez de marche angulaire
40x40 cm 16x16 in
0104



Gradone Angolare Rett. (DX-R)
Gradone Angolare Rett. (SX-L)
Corner Step / Eckstufe / Nez de marche angulaire
60x60 cm 24x24 in
0134 HQZ-HBO: 0215



Gradone Angolare Rett. (DX-R)
Gradone Angolare Rett. (SX-L)
Corner Step / Eckstufe / Nez de marche angulaire
80x80 cm 32x32 in
0317

Mezzaluna Rett. Lato 15
Crescent Rett. Side 15
Halbmond Rett. Seite 15
Bordure demi-lune Rett. Côté 15
60x60x15 cm 24x24x6 in
0185



Elemento a L Rett.
L-Shaped Trim Rett.
L-Element Rett.
Élément « L » Rett.
15x40x4 cm 6x16x1 5/8 in
0053



Elemento a L Rett.
L-Shaped Trim Rett.
L-Element Rett.
Élément « L » Rett.
15x80x4 cm 6x32x1 5/8 in
0118

Curva raccordo Rett. Convessa
Convex Rett. edge trim
Verbindungsstück Rett. konvex
Courbe raccord Rett. Convexe
30 cm 12 in
0088

Curva raccordo Rett. Concava
Concave Rett. edge trim
Verbindungsstück Rett. konkav
Courbe raccord Rett. Concave
30 cm 12 in
0075

Mezzaluna Rett. Lato 20
Crescent Rett. Side 20
Halbmond Rett. Seite 20
Bordure demi-lune Rett. Côté 20
60x60x15 cm 24x24x6 in
0175



Elemento a L Rett.
L-Shaped Trim Rett.
L-Element Rett.
Élément « L » Rett.
15x60x4 cm 6x24x1 5/8 in
0082



Angolo Griglia Rett.
Corner Grid Rett.
Gitterecke Rett.
Angle Caniveau Rett.
15x15 cm 6x6 in
0065



Griglia Rett.
Grid Rett. / Gitter Rett. / Caniveau Rett.
15x60 cm 6x24 in
0126



Angolo Griglia Rett.
Corner Grid Rett.
Gitterecke Rett.
Angle Caniveau Rett.
20x20 cm 8x8 in
0049



Griglia Rett.
Grid Rett. / Gitter Rett. / Caniveau Rett.
20x60 cm 8x24 in
0175



Griglia Rett.
Grid Rett. / Gitter Rett. / Caniveau Rett.
20x80 cm 8x32 in
0232

Per verificare in quali dei formati qui rappresentati sono realizzabili i pezzi speciali di ogni specifica serie, consultare le pagine da 28 a 67.

Availability of these special pieces on every single collection can be found at page 28 to 67.

Bitte erst das Due-Katalog von Seite 28 bis 67 prüfen, um die Lieferbarkeit von Formteilen zu den einzelnen Formaten und Serien zu erfahren!

Pour vérifier dans lesquels des formats montrés on peut réaliser les pièces spéciales, merci de consulter les pages de 28 à 67.

I tempi di consegna di tutti i pezzi speciali mostrati in queste pagine sono di 30 giorni dalla data dell'ordine.

Delivery times for all special pieces shown in these pages are 30 days from the order date.

Die Lieferzeit aller auf dieser Seite gezeigten Formteile ist von 30 Tagen nach dem Auftragsdatum.

Les délais de livraison de toutes les pièces spéciales figurant dans ces pages sont de 30 jours à compter de la date de commande.

Cappello copertura muretti
con finitura rompigoocia
Wall cap with drip edge finish
Mauerabdeckung mit Abtropfkante
Chapeau de protection pour murets avec système d'égouttage

Cappello copertura colonne
con finitura rompigoocia
Column cap with drip edge finish
Säulenabdeckung mit Abtropfkante
Chapeau de protection pour colonnes avec système d'égouttage

Fioriera realizzata con due 60x60 e 60x120
con angoli a spizza da incollare
Planter made with due 60x60 and 60x120 tiles
with canted edge corners to attach with adhesive
Blumenkasten aus Fliesen due 60x60 und 60x120 mit anzuklebenden spitzen Ecken
Bac à fleurs réalisé avec des dalles due 60x60 et 60x120 avec angles arrondis à coller

Inserimento luci led
Placement of LED lights
Einbau der LED-Lichter
Insertion de lumières led

Piano seduta panchina
Bench seat surface
Sitzfläche Bank
Plan d'appui pour banc

Fioriera realizzata con
elemento a L concavo
Planter made with concave L-trim
Blumenkasten, realisiert mit stumpfem L-Element
Bac à fleurs réalisé avec un élément « L » concave

Griglia con finitura personalizzata
Grating with personalised finish
Gitter mit individuell gestalteter Fertigung
Caniveau avec finition personnalisée

Pezzi Speciali Personalizzati

Special Personalised Parts / Individuelle gestaltete Formteile / Pièces spéciales personnalisées

Su richiesta possono essere realizzati pezzi personalizzati previo studio di fattibilità. Nell'immagine alcuni esempi.

Upon request, personalised pieces can be made, subject to a feasibility study. A few examples in the image.

Auf Anfrage können nach vorheriger Machbarkeitsstudie individuell gestaltete Teile hergestellt werden. Im Bild einige Beispiele.

Sur demande, des pièces personnalisables peuvent être réalisées après une étude de faisabilité. Voici quelques exemples sur l'image.

Terminale con lato stondato
Coping with rounded edge
Endstein mit runder Seite
Terminal à bord arrondi

Portabicicletta personalizzabile
con foro per catena antifurto
Custom bicycle rack with hole
for anti-theft chain
Individuell gestaltbarer Fahrradständer
mit Loch für Kettenschloss
Porte-bicyclette personnalisable
avec trou pour chaîne antivol



Pulizia e Manutenzione

Cleaning and maintenance / Reinigung und Wartung / Nettoyage et Entretien

Proprio per la caratteristica di grande durezza e intaccabilità da parte degli agenti esterni, **due2** può essere pulito con la quasi totalità dei detersivi. Si consiglia comunque di utilizzare semplicemente un detersivo neutro e un getto d'acqua. Per una maggiore comodità e per evitare che nell'asciugatura si creino depositi di calcare consigliamo di facilitare il drenaggio con una spazzola in gomma.

*Thanks to its great hardness and weather-resistance, **due2** can be cleaned with almost any detergent. However, we recommend simply using a mild detergent and a water jet. For greater convenience and to avoid formation of limescale deposits, we recommend facilitating drainage with a rubber brush.*

*Gerade wegen seiner enormen Härte und Angreifbarkeit seitens der äußeren Einflüsse, kann **due2** mit fast jedem Reinigungsmittel gereinigt werden. Es wird jedoch empfohlen einfach ein neutrales Reinigungsmittel und einen Wasserstrahl zu verwenden. Aus Bequemlichkeit und um zu vermeiden, dass sich beim Trocknen Kalkablagerungen bilden, empfehlen wir die Drainage mit einer Plastikbürste zu erleichtern.*

*En raison de sa grande dureté et résistance aux agents externes, **due2** peut être nettoyé avec presque tous les détergents. Il est conseillé dans tous les cas de n'utiliser qu'un détergent neutre et un jet d'eau. Pour plus de facilité et pour éviter qu'au moment du séchage ne se forment des dépôts de calcaire, nous conseillons de faciliter le drainage au moyen d'une brosse en caoutchouc.*





CARATTERISTICHE TECNICHE

TECHNICAL FEATURES
TECHNISCHE DATEN
CARACTÉRISTIQUES TECHNIQUES

SPESSORE
THICKNESS
STÄRKE
ÉPAISSEUR

RESISTENZA AL GELO
FROST RESISTANCE
FROSTBESTÄNDIGKEIT
RESISTANCE AU GEL

ASSORBIMENTO D'ACQUA
WATER ABSORPTION
WASSERAUFNAHME
ABSORPTION D'EAU

CAMPO D'IMPIEGO
CONSIGLIATO
RECOMMENDED USE
ANWENDBEREICH
PIECE D'EMPLOI CONSEILLÉE

RESISTENZA CHIMICA
CHEMICAL RESISTANCE
BESTÄNDIGKEIT GEGEN
CHEMIKALIEN
RESISTANCE CHIMIQUE

RESISTENZA
ALLA FLESSIONE
BENDING STRENGTH
BIEGEFESTIGKEIT
RÉSISTANCE AU
POINÇONNEMENT
STATIQUE

CARICO DI ROTTURA MEDIO
IN POSA SOPRAELEVATA
AVERAGE BREAKING LOAD
FOR RAISED FLOOR LAYING
DURCHSCHNITTLICHER BRUCHLAST
BEI VERLEGUNG AUF STELZLAGER
CHARGE DE RUPTURE MOYEN
EN POSE SURELEVÉE

RESISTENZA MECCANICA
MECHANICAL STRENGTH
MECHANISCHE FESTIGKEIT
RÉSISTANCE MÉCANIQUE

RESISTENZA ALLO
SCIVOLAMENTO
SLIPPING RESISTANCE
RUTSCHFESTIGKEIT
FACTEUR DE RESISTANCE
ANTI-GLISSEMENT

ASCIUTTO
DRY
TROCKEN
SEC

BAGNATO
WET
NASS
MOUILLE

FORUM[®] VIGNONI[®] ENGADINA[®] SALOON[®]
DOGMA[®] EL DORADO[®] MONTEVERDE[®]
DOLOMITI[®] BLUE PEPPER[®] EPOKAL[®] CLIMB[®]

20 mm

RESISTANT
ISO 10545.12

~0,1%
ISO 10545.3



GA UNI EN ISO 10545.13
5 UNI EN ISO 10545.14

~50 N/mm²
EN 14411 B1a

Classe 1
(~6,00 kN
carico concentrato)
EN 12825

DIN 51130
DIN 51097
ANSI 137.1 (DCOF)
BCRA

R 11
-

-
C
≥0,42
>0,40

UPGRADE[®]

20 mm

RESISTANT
ISO 10545.12

~0,1%
ISO 10545.3



GA UNI EN ISO 10545.13
5 UNI EN ISO 10545.14

~50 N/mm²
EN 14411 B1a

80x80 Classe 1
(~6,00 kN) EN 12825

40x40 Classe 2
(~8,00 kN) EN 12825

20x20 Classe 4
(~10,00 kN) EN 12825

U11 EN 1339

U14 EN 1339

DIN 51130
DIN 51097
ANSI 137.1 (DCOF)
BCRA

R 11
-

-
C
≥0,42
>0,40

STONE CAPITAL[®] ANVERSA[®]

20 mm

RESISTANT
ISO 10545.12

~0,1%
ISO 10545.3



GA UNI EN ISO 10545.13
5 UNI EN ISO 10545.14

~50 N/mm²
EN 14411 B1a

60x120 Classe 1
(~6,00 kN) EN 12825

60x60 Classe 1
(~7,00 kN) EN 12825

80x80 Classe 1
(~6,00 kN) EN 12825

DIN 51130
DIN 51097
ANSI 137.1 (DCOF)
BCRA

R 11
-

-
C
≥0,42
>0,40

NAT[®] SOUL[®] BlueQuarry[®]

20 mm

RESISTANT
ISO 10545.12

~0,1%
ISO 10545.3



GA UNI EN ISO 10545.13
5 UNI EN ISO 10545.14

~50 N/mm²
EN 14411 B1a

Classe 1
(~7,00 kN
carico concentrato)
EN 12825

U11
EN 1339

DIN 51130
DIN 51097
ANSI 137.1 (DCOF)
BCRA

R 12
-

-
C
≥0,42
>0,74

TREVI[®] DA VINCI[®]

20 mm

RESISTANT
ISO 10545.12

~0,1%
ISO 10545.3



GA UNI EN ISO 10545.13
5 UNI EN ISO 10545.14

~50 N/mm²
EN 14411 B1a

Classe 1
(~7,00 kN
carico concentrato)
EN 12825

U11
EN 1339

DIN 51130
DIN 51097
ANSI 137.1 (DCOF)
BCRA

R 11
-

-
C
≥0,42
>0,40

QUARTZ[®] BOUTIQUE[®]

20 mm

RESISTANT
ISO 10545.12

~0,1%
ISO 10545.3



GA UNI EN ISO 10545.13
5 UNI EN ISO 10545.14

~50 N/mm²
EN 14411 B1a

Classe 1
(~7,00 kN
carico concentrato)
EN 12825

DIN 51130
DIN 51097
ANSI 137.1 (DCOF)
BCRA

R 11
-

-
C
≥0,42
>0,40

| Package | 60x120 | 40x120 | 30x120 | 60x90 | 80x80 | 40x80 | 60x60 | 40x40 | 20x20 |
|---------|--------|---------|--------|---------|--------|--------|---------|---------|---------|
| Pieces | 1 | 1 | 2 | 1 | 1 | 2 | 2 | 3 | 13 |
| Mq. | 0,72 | 0,48 | 0,72 | 0,54 | 0,64 | 0,64 | 0,72 | 0,48 | 0,52 |
| Kg. | 33,00 | 21,50 | 32,50 | 24,80 | 30,00 | 28,26 | 31,80 | 23,04 | 24,96 |
| Boxes | 26 | 54 | 24 | 50 | 26 | 24 | 32 | 48 | 45 |
| Mq. | 18,72 | 25,92 | 17,28 | 27,00 | 16,64 | 15,36 | 23,04 | 23,04 | 23,40 |
| Kg. | 878,00 | 1182,00 | 813,00 | 1260,00 | 795,00 | 699,00 | 1040,00 | 1126,00 | 1144,00 |

Prova effettuata con la disposizione dei supporti indicata a pag. 17
Test performed with supports set up as shown on page 17
Prüfung bei Stelzagerpositionierung wie auf Seite 17
Test effectué avec le positionnement des plots indiqué page 17

SHADE VARIATION

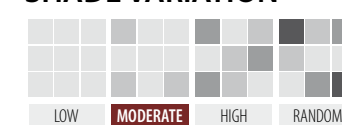

SOUL
BLUE QUARRY
ANVERSA

TREVI
BLUE PEPPER
BOUTIQUE

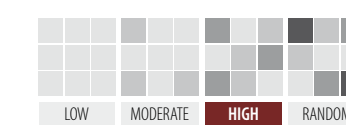

DA VINCI
DOGMA
ENGADINA

DOLOMITI
MONTEVERDE
UPGRADE

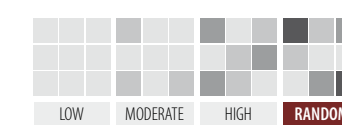

NAT
SALOON
EPOKAL

EL DORADO
STONE CAPITAL
CLIMB

FORUM
VIGNONI
QUARTZ

Informazioni e consigli di posa sono forniti a solo scopo esemplificativo; sta a progettista e committente verificare l'adeguatezza della messa in opera e il rispetto di leggi e regolamenti applicabili

Information and installation advice is provided only as an example; it is upon the designer and/or owner to verify the adequacy of the installation and compliance with applicable laws and regulations.

Information- und Verlege-Empfehlungen sind hier lediglich als Beispiel angegeben. Plattenleger und Bauherr sollten vor Ort Zweckmäßigkeit der Verlegung und sich an Gesetzen und Vorschriften halten.

Informations et conseils de pose fournis uniquement à titre d'exemple; il est au concepteur et au client de vérifier la conformité de la mise en œuvre et le respect des lois et des réglementations applicables.

due 2

Gres porcellanato a tutta massa spessore 20 mm
Through-body porcelain 20 mm thickness
Durchgefärbtes Feinsteinzeug in 20 mm Stärke
Grès cérame pleine masse épaisseur 20 mm



Ceramica del Conca S.p.a.

Via Croce, 8 - 47832 San Clemente (RN) - Italy
Tel. (+378) 0549 996037 - Fax (+378) 0549 996038

www.delconca.com - info@delconca.com

